

# TRIM TO THE TRADE

QUALITY PLUMBING SPECIALIST

2023 - 2025





Our NEW  
*Finish #38* Light Brushed Bronze



COMPLIMENTS MAJOR MANUFACTURERS'  
**BRUSHED BRONZES**





*Our Finish #35 Satin Gold*  
COMPLIMENTS MAJOR MANUFACTURER'S  
**BRUSHED BRASS**



We have an  
*Extensive Inventory* of the  
**HOTTEST FINISH**  
our *Finish #20 Flat Black*







*Our ever-popular*

FINISH #47

ENEZIAN BRONZE

compliments major manufacturers' darker bronzes





FINISH #5

**SATIN BRASS** compliments  
MAJOR MANUFACTURERS'  
*brushed brasses*





**QUALITY PLUMBING SPECIALIST**

**2023 - 2025**

ORDERS & INQUIRIES:

[customerservice@trimtothetrade.com](mailto:customerservice@trimtothetrade.com)

[trimtothetrade.com](http://trimtothetrade.com)

Office 760-343-3306

Fax 800-562-9998

77551 El Duna Court, Suite J

Palm Desert, CA 92211





## CARE & CLEANING

As with all quality plumbing supplies, care must be taken during installation and regular long term use. There is a protective coating on all goods to protect the surface from scratching or tarnishing during shipping and storage. The protective coating is not meant to withstand normal day to day use on items which come into contact with acids (found in most foods) and corrosives (found in all detergents). Trim To The Trade does not warrant the wearing quality of the protective coating.

### INSTALLATION

Decorative items should be the last items to be installed after final cleaning of the surrounding areas.

DO NOT USE putty or silicone sealer containing a curing acidic base for installation. These items will damage the protective coating through heat generation.

### CARE AND CLEANING

Use a soft cloth to clean, dampened if necessary.

DO NOT USE compounds containing acids (muriatic, phosphoric, hydrofluoric, or toluene), solvents (xylene or toluene), or other cleansers (such as bleach, alcohol, aromatic oils, or those containing abrasives).

All of these products will cause damage to the protective coating and may further damage or destroy the base material through etching or pitting.



# TABLE OF CONTENTS

PRODUCT FINISHES .....	3	1-3/8" TUBES FOR W & O .....	77
AIR GAPS & HOLE COVERS .....	4-5	<b>NEW</b> ADJUSTABLE SHOWER ROD & HOLDER .....	78
DISPOSAL FLANGE & STOPPER SETS .....	6-7	<b>NEW</b> ONE PIECE SHOWER RODS .....	79
<b>NEW</b> STOPPER STRAINER SETS .....	8	<b>NEW</b> SHOWER ROD FLANGES .....	80
DISPOSAL FLANGE & STOPPER SETS .....	9-10	SHOWER ROD HOLDERS & ACCESSORIES .....	81
LARGE BASKET STRAINERS .....	11	BRASS SHOWER HEADS .....	82
SINK & BAR STRAINERS .....	12-13	<b>NEW</b> 10" ROUND SHOWER HEAD .....	83
LOTION/SOAP DISPENSERS .....	14	<b>NEW</b> SHEPHERD'S CROOK SHOWER ARM & FLANGE ..	84
WATER DISPENSERS .....	15	<b>NEW</b> 8" ROUND SHOWER HEAD .....	85
DRAIN TRIM SETS .....	16-18	SHOWER ARMS & FLANGES .....	86-87
TRIM SET/GRILL .....	19	SHOWER ARMS .....	88-89
TILE SQUARES .....	20	SHOWER ARM FLANGES .....	90-91
SNAP-IN STRAINERS .....	21-27	VOLUME CONTROL .....	91
CROWNS .....	28	TUB SPOUTS .....	92-93
SCREWS .....	29	REMODEL PLATE .....	93
SHOWER DRAINS .....	30-31	DIVERTER SPOUTS .....	94
ROMAN TUB DRAINS .....	32-33	CLOSET SUPPLY SET .....	95-98
TANK LEVERS .....	34-37	LAVATORY SUPPLY SETS .....	99-101
CLOSET TANK ELBOW & SLIP JOINT NUT .....	37	FLAT HEAD RIGID SUPPLY TUBES .....	102
LAVATORY DRAINS .....	38-42	1/2" BULLNOSE RIGID SUPPLY TUBES .....	103
VESSEL SPACER .....	43	3/8" BULLNOSE RIGID SUPPLY TUBES .....	104
P-TRAPS (17 GAUGE) .....	44-46	1/2" IPS ANGLE STOPS .....	105-106
DECORATIVE BOTTLE TRAP .....	47	1/2" NOMINAL COMPRESSION ANGLE STOPS .....	107-108
S-TRAPS (17 GAUGE) .....	48	1/2" NOMINAL COMPRESSION ANGLE STOPS-	
SLIP JOINT EXTENSION TUBES .....	49	QUARTER TURN .....	109
TAILPIECES .....	50	1/2" IPS STRAIGHT STOPS .....	110-111
SLIP JOINT ELBOWS .....	51	1/2" NOMINAL COMPRESSION STRAIGHT STOPS ..	112-113
DOUBLE OFFSETS & SLIP JOINT NUTS .....	52	3/8" IPS ANGLE STOPS .....	114
COVER CASINGS .....	53	3/8" IPS STRAIGHT STOPS .....	115
BATH STRAINERS .....	54-56	STOPS WITH 5" EXTENSION TUBES .....	116-117
TRIP LEVER DRAIN SET .....	57	STOPS WITH CORRUGATED RISERS .....	118
W & O CONVERSION KITS .....	58-62	BRAIDED RISERS .....	119
FACE PLATES & ACCESSORIES .....	63	1/2" THREADED BRASS FITTINGS .....	120
BUSHINGS .....	64	3/8" THREADED BRASS FITTINGS .....	121
OFFSET BATH SUPPLIES .....	65	1/2" IPS NIPPLES .....	122-124
W & O TRIP LEVER STYLE .....	66-67	3/8" IPS NIPPLES .....	125
W & O LIFT & TURN STYLE .....	68-69	SURE GRIP FLANGES .....	126-127
W & O CHAIN & STOPPER .....	70	BELL FLANGES .....	128-129
W & O TIP-TOE STYLE .....	71-73	HIGH BOX FLANGES .....	130
W & O LIFT & TURN FOR FREESTANDING TUBS		LOG LIGHTER TRIM .....	131
WITH EXTENDED SHOE .....	74-75	INDEX OF PRODUCTS .....	132-134
1-1/2" TUBES FOR W & O .....	76	TERMS & CONDITIONS OF SALE .....	135





**Trim to the Trade has an extensive inventory in many finishes**



























**Grill 4T-031 on Page 19**





# PRODUCT FINISHES

**Color Set:** We have “Color Sets” available to all of our customers for sampling purposes. Contact Customer Service for a complimentary set.

Finish	Code	Name	Finish	Code	Name
	1	Polished Chrome		30	Polished Nickel
	2	Polished Brass & PVD		31	Satin Nickel
	3	Antique Brass		32	Light Gold
	4	Antique Nickel (Pewter)		33	Antique Bronze
	5	Satin Brass		34	Oil Rubbed Bronze
	6	Satin Chrome		35	Satin Gold
	7	Polished Copper		36	Antique Copper
	8	Polished Gold		37	Satin Copper
	11	Uncoated Polished Brass		38	Light Brushed Bronze
	12	Black Nickel		40	Aged Pewter
	13	White		45	Matte Gold
	15	Gloss Black		46	Antique Gold
	16	Biscuit		47	Venezian Bronze
	19	Almond		48	Polished Bronze
	20	Flat Black		50	Brushed Nickel (Stainless)

COLOR DISCLAIMER: Actual product colors may vary from colors shown in the catalog.



# AIR GAPS

4T-202 & 4T-203



4T-203

## BRASS METAL AIR GAP CAP ONLY (NO RIM) | 4T-203

2-1/4" TALL

1-5/8" OD



4T-202

## COMPLETE AIR GAP KIT (NO RIM) | 4T-202

PLASTIC BODY WITH BRASS CAP

IAPMO APPROVE

### 4T-202 & 4T-203

#### FINISHES & PRICE GROUPS:

##### PRICE GROUP A

- Polished Chrome (1)

##### PRICE GROUP B

- White (13)
- Gloss Black (15)
- Biscuit (16)
- Almond (19)
- Flat Black (20)

##### PRICE GROUP C

- Polished Brass & PVD (2)
- Antique Brass (3)
- Antique Nickel (Pewter) (4)
- Satin Brass (5)
- Satin Chrome (6)
- Polished Nickel (30)
- Satin Nickel (31)
- Oil Rubbed Bronze (34)
- Stainless/Brushed Nickel (50)

##### PRICE GROUP D

- Polished Copper (7)
- Uncoated Polished Brass (11)
- Antique Bronze (33)
- Satin Gold (35)
- Antique Copper (36)
- Satin Copper (37)
- Light Brushed Bronze (38)
- Venezian Bronze (47)



# AIR GAPS & HOLE COVERS

4T-204, 4T-205 & 4T-200

## BRASS METAL AIR GAP CAP ONLY WITH RIM | 4T-204

SITS FLUSH WITH COUNTERTOP 2-1/4" TALL 1-7/8" OD AT BASE



4T-204

### 4T-204 & 4T-205 FINISHES & PRICE GROUPS:

#### PRICE GROUP A

- Polished Chrome (1)

#### PRICE GROUP B

- White (13)
- Gloss Black (15)
- Biscuit (16)
- Almond (19)
- Flat Black (20)

#### PRICE GROUP C

- Polished Brass & PVD (2)
- Antique Brass (3)
- Antique Nickel (Pewter) (4)

- Satin Brass (5)
- Satin Chrome (6)
- Polished Nickel (30)
- Satin Nickel (31)
- Oil Rubbed Bronze (34)
- Stainless/Brushed Nickel (50)

#### PRICE GROUP D

- Uncoated Polished Brass (11)
- Satin Gold (35)
- Light Brushed Bronze (38)
- Venezian Bronze (47)



4T-205

## AIR GAP KIT WITH RIM 4T-205

PLASTIC BODY WITH BRASS CAP

IAPMO APPROVED

### 4T-200 FINISHES & PRICE GROUPS:

#### PRICE GROUP A

- Polished Chrome (1)

#### PRICE GROUP B

- White (13)
- Gloss Black (15)
- Biscuit (16)
- Almond (19)
- Flat Black (20)

#### PRICE GROUP C

- Polished Brass & PVD (2)
- Antique Brass (3)
- Antique Nickel (Pewter) (4)
- Satin Brass (5)
- Satin Chrome (6)
- Polished Nickel (30)
- Satin Nickel (31)

- Oil Rubbed Bronze (34)
- Stainless/Brushed Nickel (50)

#### PRICE GROUP D

- Polished Copper (7)
- Polished Gold (8)
- Uncoated Polished Brass (11)
- Light Gold (32)
- Antique Bronze (33)
- Satin Gold (35)
- Antique Copper (36)
- Satin Copper (37)
- Light Brushed Bronze (38)
- Matte Gold (45)
- Antique Gold (46)
- Venezian Bronze (47)
- Polished Bronze (48)



4T-200

## 2" FAUCET HOLE COVER | 4T-200

SOLID TOP



# DISPOSAL FLANGE & STOPPER SETS

4T-209K, 4T-209 & 4T-210



4T-209K

## FLANGE & STOPPER SET | 4T-209K

FLANGE (4T-209) AND STOPPER (4T-210)

FITS ISE BADGER, KENMORE, MAYTAG, MOEN AND KITCHENAID

1-7/16" DEEP



4T-209

## GARBAGE DISPOSAL FLANGE ONLY | 4T-209

FITS ISE BADGER, KENMORE, MAYTAG, MOEN AND KITCHENAID

1-7/16" DEEP



4T-210

## GARBAGE DISPOSAL STOPPER ONLY | 4T-210

FITS ISE BADGER, KENMORE, MAYTAG, MOEN AND KITCHENAID

FITS 4T-209 AND 4T-207 FLANGES

### 4T-209K, 4T-209 & 4T-210 FINISHES & PRICE GROUPS:

#### PRICE GROUP A

- Polished Chrome (1)

#### PRICE GROUP B

- White (13)
- Gloss Black (15)
- Almond (19)
- Flat Black (20)

#### PRICE GROUP C

- Polished Brass & PVD (2)
- Antique Brass (3)
- Antique Nickel (Pewter) (4)
- Satin Brass (5)
- Satin Chrome (6)

- Polished Nickel (30)
- Satin Nickel (31)
- Oil Rubbed Bronze (34)
- Stainless/Brushed Nickel (50)

#### PRICE GROUP D

- Polished Copper (7)
- Polished Gold (8)
- Uncoated Polished Brass (11)
- Light Gold (32)
- Satin Gold (35)
- Antique Copper (36)
- Satin Copper (37)
- Light Brushed Bronze (38)
- Venezian Bronze (47)



# DISPOSAL FLANGE & STOPPER SETS

4T-208 & 4T-207

## DEEP FLANGE & STOPPER SET | 4T-208

DEEP FLANGE (4T-207) AND STOPPER (4T-210)

FITS ISE BADGER, KENMORE, MAYTAG AND KITCHENAID

2-3/8" DEEP-FITS



4T-208

## DEEP GARBAGE DISPOSAL FLANGE ONLY | 4T-207

FITS ISE BADGER, KENMORE, MAYTAG, AND KITCHENAID

2-3/8" DEEP



4T-207

### 4T-208 & 4T-207 FINISHES & PRICE GROUPS:

#### PRICE GROUP A

- Polished Chrome (1)

#### PRICE GROUP B

- White (13)
- Gloss Black (15)
- Biscuit (16)
- Almond (19)
- Flat Black (20)

#### PRICE GROUP C

- Polished Brass & PVD (2)
- Antique Brass (3)
- Antique Nickel (Pewter) (4)

- Satin Brass (5)
- Satin Chrome (6)
- Polished Nickel (30)
- Satin Nickel (31)
- Oil Rubbed Bronze (34)
- Stainless/Brushed Nickel (50)

#### PRICE GROUP D

- Uncoated Polished Brass (11)
- Satin Gold (35)
- Antique Copper (36)
- Light Brushed Bronze (38)
- Venezian Bronze (47)

# STOPPER-STRAINER SETS

4T-206, 4T-236 & 4T-237

NEW



4T-206

## STOPPER-STRAINER | 4T-206

COMBINATION GARBAGE DISPOSAL STOPPER AND SINK STRAINER  
STRAINER IS 3.1" IN DIAMETER, STOPPER IS 3.3" IN DIAMETER



4T-236

## STOPPER-STRAINER SET | 4T-236

INCLUDES STOPPER-STRAINER (4T-206) AND  
GARBAGE DISPOSAL FLANGE (4T-209)  
FLANGE IS 1-7/16" DEEP



4T-237

## DEEP FLANGE STOPPER-STRAINER SET | 4T-237

INCLUDES STOPPER-STRAINER (4T-206) AND DEEP GARBAGE DISPOSAL  
FLANGE (4T-207)  
FLANGE IS 2-3/8" DEEP

### 4T-206, 4T-236 & 4T-237 FINISHES & PRICE GROUPS:

#### PRICE GROUP A

- Polished Chrome (1)

#### PRICE GROUP B

- White (13)
- Flat Black (20)

#### PRICE GROUP C

- Polished Brass & PVD (2)
- Polished Nickel (30)
- Satin Nickel (31)
- Oil Rubbed Bronze (34)
- Stainless/Brushed Nickel (50)



# DISPOSAL FLANGE & STOPPER SETS

4T-213K, 4T-213A & 4T-213S

## FLANGE & STOPPER SET | 4T-213K

INCLUDES FLANGE (4T-213A) AND STOPPER (4T-213S)  
FITS WASTE KING GOURMET EASY MOUNT, WASTE KING LEGEND SERIES, ELIMINATOR, GIBSON, CALORIC, FRIGIDAIRE, GE, KELVINATOR, MAGIC CHEF, MR. ROOTER, MODERN MAID, M. WARD, PHCC, SINKMASTER, TAPPAN/O'KEEFE, WHIRLWAY AND WHITE-WESTINGHOUSE



## GARBAGE DISPOSAL FLANGE ONLY | 4T-213A

2-1/4" DEEP  
1-1/4" THREADS WITH TEETH

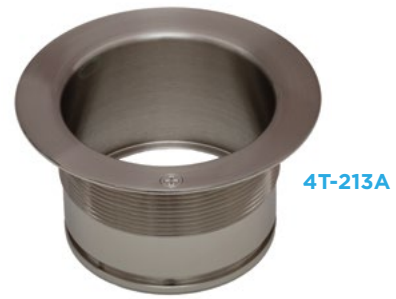

## GARBAGE DISPOSAL STOPPER | 4T-213S



### 4T-213K, 4T-213A & 4T-213S FINISHES & PRICE GROUPS:

#### PRICE GROUP A

- Polished Chrome (1)

#### PRICE GROUP B

- White (13)
- Gloss Black (15)
- Biscuit (16)
- Almond (19)
- Flat Black (20)

#### PRICE GROUP C

- Polished Brass & PVD (2)
- Antique Nickel (Pewter) (4)
- Satin Chrome (6)
- Polished Nickel (30)
- Satin Nickel (31)
- Oil Rubbed Bronze (34)
- Stainless/Brushed Nickel (50)

#### PRICE GROUP D

- Venezian Bronze (47)

# DISPOSAL FLANGE & STOPPER SETS

4T-214, 4T-211 & 4T-212



4T-214

## GARBAGE DISPOSAL FLANGE & STOPPER SET | 4T-214

INCLUDES FLANGE (4T-211) AND STOPPER (4T-212)

FITS WASTE KING GOURMET CUSTOM SERIES 3 BOLT MOUNT AND WHIRLAWAY

PRO 3 BOLT MOUNT

1-3/4" DEEP



4T-211

## GARBAGE DISPOSAL FLANGE ONLY | 4T-211

FITS WASTE KING GOURMET CUSTOM SERIES 3 BOLT AND

WHIRLAWAY, PRO 3 BOLT MODELS



4T-212

## GARBAGE DISPOSAL STOPPER ONLY | 4T-212

FITS WASTE KING GOURMET CUSTOM SERIES 3 BOLT AND

WHIRLAWAY PRO 3 BOLT MODELS

### 4T-214, 4T-211 & 4T-212 FINISHES & PRICE GROUPS:

#### PRICE GROUP A

- Polished Chrome (1)

#### PRICE GROUP B

- White (13)
- Gloss Black (15)
- Almond (19)
- Flat Black (20)

#### PRICE GROUP C

- Polished Brass & PVD (2)
- Antique Brass (3)
- Antique Nickel (Pewter) (4)

- Satin Brass (5)

- Satin Chrome (6)

- Polished Nickel (30)

- Satin Nickel (31)

- Oil Rubbed Bronze (34)

- Stainless/Brushed Nickel (50)

#### PRICE GROUP D

- Polished Copper (7)

- Antique Copper (36)

- Venezian Bronze (47)



# LARGE BASKET STRAINERS

4T-231 & 4T-242

## LARGE BASKET STRAINER WITH POST BASKET | 4T-231

INCLUDES BRASS NUTS & WASHERS

LARGE BASKET STRAINER AND POST STYLE BASKET (4T-232)

FITS 3-1/2" TO 4" OPENING

4-3/8" FLANGE DIAMETER

2-1/2" DEEP WITH 1-1/2" THREAD



4T-231

## LARGE BASKET STRAINER WITH LOCKING WING NUT | 4T-242

INCLUDES BRASS NUTS AND WASHERS

LARGE BASKET STRAINER AND WING NUT LOCKING STYLE BASKET (4T-243)

FITS 3-1/2" TO 4" OPENING

4-3/8" FLANGE DIAMETER

2-1/2" DEEP WITH 1-1/2" THREAD



4T-242

### 4T-231 & 4T-242 FINISHES & PRICE GROUPS:

#### PRICE GROUP A

- Polished Chrome (1)

#### PRICE GROUP B

- White (13)
- Gloss Black (15)
- Biscuit (16)
- Almond (19)
- Flat Black (20)

#### PRICE GROUP C

- Polished Brass & PVD (2)
- Antique Brass (3)
- Antique Nickel (Pewter) (4)
- Satin Brass (5)

- Satin Chrome (6)
- Polished Nickel (30)
- Satin Nickel (31)
- Oil Rubbed Bronze (34)
- Stainless/Brushed Nickel (50)

#### PRICE GROUP D

- Polished Copper (7)
- Uncoated Polished Brass (11)
- Satin Gold (35)
- Antique Copper (36)
- Satin Copper (37)
- Light Brushed Bronze (38)
- Venezian Bronze (47)

# SINK & BAR STRAINERS

4T-233, 4T-234 & 4T-235



4T-233

## JUNIOR BASKET STRAINER WITH BASKET | 4T-233

INCLUDES BASKET (4T-234)

COMPLETE WITH NUTS & WASHERS

FITS 2" OPENING

2-5/8" DEEP

2-7/8" FLANGE DIAMETER



4T-234

## JUNIOR BASKET ONLY | 4T-234

2-1/8" DEEP



4T-235

## JUNIOR BASKET WITH 3-PRONG STRAINER | 4T-235

INCLUDES JUNIOR BASKET STRAINER (4T-233) AND 1-7/8" OD 3-PRONG STRAINER (4T-241)

COMPLETE WITH NUTS & WASHERS

FITS 2" OPENING

### 4T-233, 4T-234 & 4T-235 FINISHES & PRICE GROUPS:

#### PRICE GROUP A

- Polished Chrome (1)

#### PRICE GROUP B

- White (13)
- Gloss Black (15)
- Almond (19)
- Flat Black (20)

#### PRICE GROUP C

- Polished Brass & PVD (2)
- Antique Nickel (Pewter) (4)
- Satin Brass (5)
- Satin Chrome (6)
- Polished Nickel (30)

- Satin Nickel (31)
- Oil Rubbed Bronze (34)
- Stainless/Brushed Nickel (50)

#### PRICE GROUP D

- Polished Copper (7)
- Polished Gold (8)
- Black Nickel (12)
- Satin Gold (35)
- Antique Copper (36)
- Satin Copper (37)
- Light Brushed Bronze (38)
- Venezian Bronze (47)



# SINK & BAR STRAINERS

4T-238 & 4T-240



## MIDGET DUO SINK STRAINER WITH BASKET | 4T-238

COMPLETE WITH NUTS & WASHERS

1-1/4" BASKET DEPTH

FITS 2" OPENING

2-3/4" FLANGE DIAMETER

## SINK PLUG WITH 3-PRONG STRAINER | 4T-240

COMPLETE WITH NUTS & WASHERS

FOR REGULAR OR BAR SINKS

COARSE THREAD 11-1/2" PER INCH

FITS 2" OPENING

1-9/16" DEEP

2-7/8" FLANGE DIAMETER



### 4T-238 & 4T-240 FINISHES & PRICE GROUPS:

#### PRICE GROUP A

- Polished Chrome (1)

#### PRICE GROUP B

- White (13)
- Gloss Black (15)
- Biscuit (16)
- Almond (19)
- Flat Black (20)

#### PRICE GROUP C

- Polished Brass & PVD (2)
- Antique Brass (3)
- Satin Brass (5)
- Satin Chrome (6)

- Polished Nickel (30)
- Satin Nickel (31)
- Oil Rubbed Bronze (34)
- Stainless/Brushed Nickel (50)

#### PRICE GROUP D

- Black Nickel (12)
- Satin Gold (35)
- Antique Copper (36)
- Satin Copper (37)
- Venezian Bronze (47)

# LOTION/SOAP DISPENSERS

4T-215, 4T-215B & 4T-215C

All Lotion/Soap Dispensers include a 13 oz plastic bottle



4T-215

## ECONOMY LOTION/SOAP DISPENSER | 4T-215

SOLID BRASS - 8" STRAW



4T-215B

## HEAVY DUTY LOTION/SOAP DISPENSER | 4T-215B

SOLID BRASS - 9" STRAW



4T-215C

## DECORATIVE HOOK STYLE LOTION/SOAP DISPENSER | 4T-215C

SOLID BRASS - 9" STRAW

### 4T-215, 4T-215B & 4T-215C FINISHES & PRICE GROUPS:

#### PRICE GROUP A

- Polished Chrome (1)

#### PRICE GROUP B

- White (13)
- Gloss Black (15)
- Biscuit (16)
- Almond (19)
- Flat Black (20)

#### PRICE GROUP C

- Polished Brass & PVD (2)
- Antique Brass (3)
- Antique Nickel (Pewter) (4)
- Satin Brass (5)
- Satin Chrome (6)
- Polished Nickel (30)
- Satin Nickel (31)
- Oil Rubbed Bronze (34)
- Stainless/Brushed Nickel (50)

#### PRICE GROUP D

- Antique Bronze (33)
- Satin Gold (35)
- Antique Copper (36)
- Light Brushed Bronze (38)
- Venezian Bronze (47)

### LOTION DISPENSERS EXTENSIONS 4T-215-KIT & 4T-215BC-KIT



#### EXTENSION KIT FOR 4T-215

4T-215-KIT

APPROX. 2-1/4" NIPPLE FOR THICKER

COUNTERTOPS - 8" STRAW

#### EXTENSION KIT FOR 4T-215B

& 4T-215C | 4T-215BC-KIT

APPROX. 2-1/4" NIPPLE FOR THICKER

COUNTERTOPS - 9" STRAW

PRICE GROUP A



# WATER DISPENSERS

4T-216, 4T-218 & 4T-217 *Plus* REPAIR KIT 4T-216-KIT

## 6" WATER DISPENSER FOR FILTERED WATER | 4T-216

7/16" DIAMETER HOLE REQUIRED FOR INSTALLATION

INPUT FOR 1/4" COMPRESSION FAUCET PART ONLY FOR FILTERED WATER



4T-216

## 8" WATER DISPENSER FOR FILTERED WATER | 4T-218

FAUCET PART ONLY FOR FILTERED WATER

2-1/2" SPUD FOR THICKER COUNTERTOPS



4T-218

## 10" WATER DISPENSER FOR FILTERED WATER | 4T-217

FAUCET PART ONLY FOR FILTERED WATER

2-1/2" SPUD FOR THICKER COUNTERTOPS



4T-217

**PLEASE NOTE\*** WATER DISPENSERS ARE NOT USABLE AS AN INSTANT HOT OR REVERSE OSMOSIS



**REPAIR KIT FOR 216, 217 & 218 | 4T-216-KIT**  
INCLUDES HANDLE, SPRING, O-RING AND NUT

**PRICE GROUP A**

**4T-216, 4T-218 & 4T-217 FINISHES & PRICE GROUPS:**

**PRICE GROUP A**

- Polished Chrome (1)

**PRICE GROUP B**

- White (13)
- Flat Black (20)

**PRICE GROUP C**

- Polished Brass & PVD (2)
- Polished Nickel (30)
- Satin Nickel (31)
- Oil Rubbed Bronze (34)
- Stainless/Brushed Nickel (50)

**PRICE GROUP D**

- Antique Bronze (33)  
4T-217 & 4T-218 only
- Satin Gold (35)
- Antique Copper (36)  
4T-216 & 4T-218 only
- Light Brushed Bronze (38)
- Venezian Bronze (47)

# DRAIN TRIM SETS

4T-030, 4T-040 & 4T-3040



4T-030

## DRAIN TRIM SET | 4T-030

Includes GRILL (4T-031)

CROWN (4T-032)

SCREWS (4T-033)

FITS PLUMBING PRODUCTS, PASCO AND AMERICAN  
BRASS & ALUMINUM DRAINS

GRILL IS 3-3/8" OD DIAMETER

SCREW HOLES ARE 2-7/8" CENTER-TO-CENTER



4T-040

## TILE SQUARE | 4T-040

4-1/4" OD - 3-5/8" ID

FITS PLUMBING PRODUCTS DRAINS

4T-3040



## PLUMBING PRODUCTS DRAIN TRIM SET | 4T-3040

INCLUDES DRAIN TRIM SET (4T-030) WITH TILE SQUARE (4T-040)

### 4T-030, 4T-040 & 4T-3040 FINISHES & PRICE GROUPS:

#### PRICE GROUP A

- Polished Chrome (1)

#### PRICE GROUP B

- White (13)
- Almond (19)
- Flat Black (20)

#### PRICE GROUP C

- Polished Brass & PVD (2)
- Antique Brass (3)
- Antique Nickel (Pewter) (4)
- Satin Brass (5)
- Satin Chrome (6)
- Polished Nickel (30)

- Satin Nickel (31)
- Oil Rubbed Bronze (34)
- Stainless/Brushed Nickel (50)

#### PRICE GROUP D

- Polished Gold (8)  
4T-030 only
- Light Gold (32)
- Antique Bronze (33)  
4T-030 only
- Satin Gold (35)
- Light Brushed Bronze (38)
- Aged Pewter (40)
- Venezian Bronze (47)

# DRAIN TRIM SETS

4T-029, 4T-2940, 4T-042, & 4T-4240

## DRAIN TRIM SET W/ SNAP IN STRAINER | 4T-029

INCLUDES 3-1/4" STRAINER (4T-045) AND CROWN (4T-046)

FITS FRANK PATTERN (INSTANT SET) SHOWER DRAIN



4T-029

## DELUXE TRIM SET W/ TILE SQUARE | 4T-2940

INCLUDES DRAIN TRIM SET (4T-029) WITH TILE SQUARE (4T-040)

FITS FRANK PATTERN (INSTANT SET) SHOWER DRAIN



4T-2940

## DRAIN TRIM SET | 4T-042

INCLUDES GRILL (4T-031), CROWN (4T-042GC) AND SCREWS (4T-033)

FITS OATEY

GRILL IS 3-3/8" OD DIAMETER

SCREW HOLES ARE 2-7/8" CENTER-TO-CENTER



4T-042

## DRAIN TRIM SET | 4T-4240

INCLUDES DRAIN TRIM SET (4T-042) AND TILE SQUARE (4T-040)

FITS OATEY



4T-4240

### 4T-029, 4T-2940, 4T-042, & 4T-4240 FINISHES & PRICE GROUPS:

#### PRICE GROUP A

- Polished Chrome (1)

#### PRICE GROUP B

- White (13)
- Biscuit (16)
- Almond (19)
- Flat Black (20)

#### PRICE GROUP C

- Polished Brass & PVD (2)
- Antique Brass (3)
- Antique Nickel (Pewter) (4)
- Satin Brass (5)

- Satin Chrome (6)

- Polished Nickel (30)
- Satin Nickel (31)
- Oil Rubbed Bronze (34)
- Stainless/Brushed Nickel (50)

#### PRICE GROUP D

- Satin Gold (35)
- Light Brushed Bronze (38)
- Aged Pewter (40)
- Venezian Bronze (47)



# DRAIN TRIM SETS

4T-090 & 4T-091



## DRAIN TRIM SET | 4T-090

GRILL (4T-092) AND SCREWS (4T-094 & 4T-095)

FITS PLASTIC ODDITIES RECEPTOR DRAINS, C.P. INDUSTRIES, RICHMOND FOUNDRY,  
PRIER BRASS AND RAPID FIT DRAINS

4" DIAMETER

SCREW HOLES ARE 3-3/8" CENTER-TO-CENTER



## DRAIN TRIM SET | 4T-091

GRILL (4T-093) AND SCREWS (4T-094 & 4T-095)

FITS PLASTIC ODDITIES SHOWER DRAIN AND SIOUX CHIEF  
4-1/4" DIAMETER

SCREW HOLES ARE 2-5/8" CENTER-TO-CENTER

### 4T-090 & 4T-091 FINISHES & PRICE GROUPS:

#### PRICE GROUP A

- Polished Chrome (1)

#### PRICE GROUP B

- White (13)
- Gloss Black (15) 4T-091 only
- Biscuit (16)
- Almond (19)
- Flat Black (20)

#### PRICE GROUP C

- Polished Brass & PVD (2)
- Antique Brass (3)
- Antique Nickel (Pewter) (4)
- Satin Brass (5)
- Satin Chrome (6)

- Polished Nickel (30)
- Satin Nickel (31)
- Oil Rubbed Bronze (34)
- Stainless/Brushed Nickel (50)

#### PRICE GROUP D

- Polished Copper (7)
- Polished Gold (8)
- Uncoated Polished Brass (11)
- Light Gold (32)
- Antique Bronze (33)
- Satin Gold (35)
- Antique Copper (36)
- Light Brushed Bronze (38)
- Aged Pewter (40)
- Venezan Bronze (47)

# TRIM SET/GRILL

4T-034 & 4T-031

## 3-3/8" GRILL SET | 4T-034

GRILL (4T-031) & SCREWS (4T-033)  
FITS PLUMBING PRODUCTS, PASCO, OATEY AND AMERICAN  
BRASS & ALUMINUM DRAINS  
SCREW HOLES ARE 2-7/8" CENTER-TO-CENTER

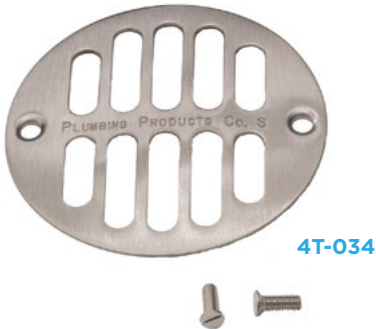

## 3-3/8" OD GRILL ONLY | 4T-031

SCREWS NOT INCLUDED  
FITS PLUMBING PRODUCTS, PASCO, AMERICAN BRASS & ALUMINUM  
AND OATEY DRAINS  
SCREW HOLES ARE 2-7/8" CENTER-TO-CENTER



### 4T-034 & 4T-031 FINISHES & PRICE GROUPS:

#### PRICE GROUP A

- Polished Chrome (1)

#### PRICE GROUP B

- White (13)
- Almond (19)
- Flat Black (20)

#### PRICE GROUP C

- Polished Brass & PVD (2)
- Antique Brass (3)
- Antique Nickel (Pewter) (4)
- Satin Brass (5)

- Satin Chrome (6)
- Polished Nickel (30)
- Satin Nickel (31)
- Oil Rubbed Bronze (34)
- Stainless/Brushed Nickel (50)

#### PRICE GROUP D

- Polished Gold (8)
- Antique Bronze (33)
- Satin Gold (35)
- Light Brushed Bronze (38)
- Aged Pewter (40)
- Venezian Bronze (47)

# TILE SQUARES

4T-039 & 4T-040



4T-039

## TILE SQUARE | 4T-039

5-3/4" OD - 4-3/8" ID

FITS PLUMBING PRODUCTS DRAINS



4T-040

## TILE SQUARE | 4T-040

4-1/4" OD - 3-5/8" ID

FITS PLUMBING PRODUCTS DRAINS

### 4T-039 & 4T-040 FINISHES & PRICE GROUPS:

#### PRICE GROUP A

- Polished Chrome (1)

#### PRICE GROUP B

- White (13)
- Almond (19)
- Flat Black (20)

#### PRICE GROUP C

- Polished Brass & PVD (2)
- Antique Brass (3)
- Antique Nickel (Pewter) (4)
- Satin Brass (5)
- Satin Chrome (6)
- Polished Nickel (30)

- Satin Nickel (31)
- Oil Rubbed Bronze (34)
- Stainless/Brushed Nickel (50)

#### PRICE GROUP D

- Antique Bronze (33)  
4T-039 only
- Satin Gold (35)
- Antique Copper (36)  
4T-039 only
- Light Brushed Bronze (38)
- Aged Pewter (40)
- Venezian Bronze (47)



# SNAP-IN STRAINERS

4T-043

OUR MOST  
POPULAR  
SNAP-IN  
STRAINER

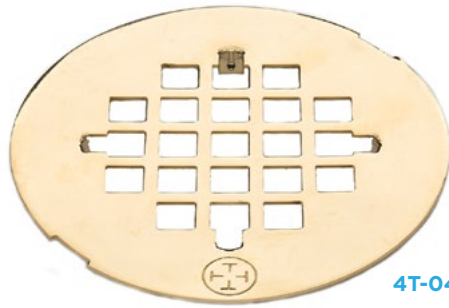

4T-043



4T-043



4T-043

## 4-1/4" OD SNAP-IN STRAINER | 4T-043

FITS OATEY, INTERCON, B & K IND., PRIER BRASS,  
SCHIER, SIOUX CHIEF, SWAN AND AQUA GLASS SHOWER  
RECEPTOR DRAINS  
PRONG TO PRONG DIAMETER 2-7/8"

### 4T-043 FINISHES & PRICE GROUPS:

#### PRICE GROUP A

- Polished Chrome (1)

#### PRICE GROUP B

- White (13)
- Biscuit (16)
- Almond (19)
- Flat Black (20)

#### PRICE GROUP C

- Polished Brass & PVD (2)
- Antique Brass (3)
- Antique Nickel (Pewter) (4)
- Satin Brass (5)

- Satin Chrome (6)
- Polished Nickel (30)
- Satin Nickel (31)
- Oil Rubbed Bronze (34)
- Stainless/Brushed Nickel (50)

#### PRICE GROUP D

- Uncoated Polished Brass (11)
- Satin Gold (35)
- Antique Copper (36)
- Light Brushed Bronze (38)
- Aged Pewter (40)
- Veneizian Bronze (47)

# SNAP-IN STRAINERS

4T-041 & 4T-044

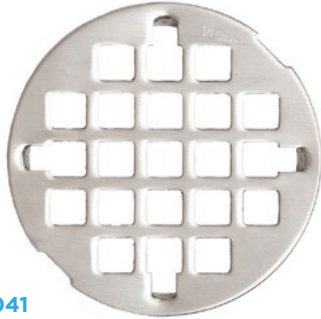

4T-041

## SNAP-IN STRAINER | 4T-041

FITS OATEY #109

3-1/4" OD

PRONG-TO-PRONG DIAMETER IS 2-7/8"



4T-044

## 4-1/4" OD SNAP-IN STRAINER ONLY | 4T-044

FITS SWANSTONE DRAINS AND SIOUX CHIEF

PRONG TO PRONG DIAMETER 2-7/8"

PRONG LENGTH APPROX. 5/8"

### 4T-041 FINISHES & PRICE GROUPS:

#### PRICE GROUP A

- Polished Chrome (1)

#### PRICE GROUP B

- White (13)
- Gloss Black (15)
- Biscuit (16)
- Almond (19)
- Flat Black (20)

#### PRICE GROUP C

- Polished Brass & PVD (2)
- Antique Brass (3)
- Antique Nickel (Pewter) (4)
- Satin Brass (5)
- Polished Nickel (30)
- Satin Nickel (31)
- Oil Rubbed Bronze (34)
- Stainless/Brushed Nickel (50)

#### PRICE GROUP D

- Antique Bronze (33)
- Satin Gold (35)
- Light Brushed Bronze (38)
- Venezian Bronze (47)

### 4T-044 FINISHES & PRICE GROUPS:

#### PRICE GROUP A

- Polished Chrome (1)

#### PRICE GROUP B

- Flat Black (20)

#### PRICE GROUP C

- Polished Brass & PVD (2)
- Antique Nickel (Pewter) (4)
- Satin Chrome (6)
- Satin Nickel (31)
- Oil Rubbed Bronze (34)
- Stainless/Brushed Nickel (50)

# SNAP-IN STRAINERS

4T-045 & 4T-047

## 4T-045 FINISHES & PRICE GROUPS:

### PRICE GROUP A

- Polished Chrome (1)

### PRICE GROUP B

- White (13)
- Gloss Black (15)
- Biscuit (16)
- Almond (19)
- Flat Black (20)

### PRICE GROUP C

- Polished Brass & PVD (2)
- Antique Brass (3)
- Antique Nickel (Pewter) (4)
- Satin Brass (5)
- Satin Chrome (6)
- Polished Nickel (30)
- Satin Nickel (31)
- Oil Rubbed Bronze (34)
- Stainless/Brushed Nickel (50)

### PRICE GROUP D

- Uncoated Polished Brass (11)
- Black Nickel (12)
- Antique Bronze (33)
- Satin Gold (35)
- Antique Copper (36)
- Light Brushed Bronze (38)
- Aged Pewter (40)
- Venezian Bronze (47)



4T-045

## 3-1/4" OD SNAP IN STRAINER | 4T-045

FITS FRANK PATTERN (INSTANT SET) SHOWER DRAIN

PRONG TO PRONG DIAMETER 2-7/8"

## 4T-047 FINISHES & PRICE GROUPS:

### PRICE GROUP A

- Polished Chrome (1)

### PRICE GROUP B

- Biscuit (16)
- Almond (19)
- Flat Black (20)

### PRICE GROUP C

- Polished Brass & PVD (2)
- Antique Brass (3)
- Antique Nickel (Pewter) (4)
- Satin Brass (5)
- Satin Chrome (6)
- Polished Nickel (30)
- Satin Nickel (31)
- Oil Rubbed Bronze (34)
- Stainless/Brushed Nickel (50)

### PRICE GROUP D

- Polished Gold (8)
- Satin Gold (35)
- Satin Copper (37)
- Light Brushed Bronze (38)
- Venezian Bronze (47)



4T-047

## 4-1/4" OD SNAP-IN STRAINER | 4T-047

FITS AMERICAN BRASS & ALUMINUM SHOWER DRAINS

PRONG-TO-PRONG DIAMETER IS 2-7/8"



# SNAP-IN STRAINERS

4T-049 & 4T-049J



4T-049

## 4-1/2" OD SNAP-IN STRAINER | 4T-049

FITS FIAT CASCADE SHOWER DRAINS

PRONG-TO-PRONG DIAMETER IS 3-1/8"

### 4T-049 FINISHES & PRICE GROUPS:

#### PRICE GROUP A

- Polished Chrome (1)

#### PRICE GROUP B

- White (13)
- Almond (19)
- Flat Black (20)

#### PRICE GROUP C

- Polished Brass & PVD (2)
- Antique Brass (3)
- Antique Nickel (Pewter) (4)
- Satin Brass (5)
- Satin Chrome (6)
- Polished Nickel (30)
- Satin Nickel (31)
- Oil Rubbed Bronze (34)
- Stainless/Brushed Nickel (50)

#### PRICE GROUP D

- Antique Bronze (33)
- Satin Gold (35)
- Venezian Bronze (47)



4T-049J

## 4" OD STRAINER | 4T-049J

FITS FIAT TERRAZZO OR MOLDED STONE SHOWER

FLOORS (MFT)

### 4T-049J

#### FINISHES & PRICE GROUPS:

#### PRICE GROUP A

- Polished Chrome (1)

#### PRICE GROUP C

- Polished Brass & PVD (2)
- Antique Brass (3)
- Satin Brass (5)
- Satin Nickel (31)
- Oil Rubbed Bronze (34)
- Stainless/Brushed Nickel (50)

# SNAP-IN STRAINERS

4T-063 & 4T-0663J

## 4T-063 FINISHES & PRICE GROUPS:

### PRICE GROUP A

- Polished Chrome (1)

### PRICE GROUP B

- White (13)
- Gloss Black (15)
- Biscuit (16)
- Almond (19)
- Flat Black (20)

### PRICE GROUP C

- Polished Brass & PVD (2)
- Antique Brass (3)
- Satin Brass (5)
- Satin Chrome (6)
- Polished Nickel (30)
- Satin Nickel (31)
- Oil Rubbed Bronze (34)
- Stainless/Brushed Nickel (50)

### PRICE GROUP D

- Satin Gold (35)
- Light Brushed Bronze (38)
- Venezian Bronze (47)



4T-063

## 4-1/4" OD SNAP-IN STRAINER | 4T-063

FITS FLORESTONE SHOWER PAN DRAINS

PRONG-TO-PRONG DIAMETER IS 3"

## 4T-0663J

### FINISHES & PRICE GROUPS:

### PRICE GROUP A

- Polished Chrome (1)

### PRICE GROUP B

- White (13)
- Biscuit (16)
- Flat Black (20)

### PRICE GROUP C

- Polished Brass & PVD (2)
- Antique Brass (3)
- Satin Brass (5)
- Satin Nickel (31)
- Oil Rubbed Bronze (34)
- Stainless/Brushed Nickel (50)

### PRICE GROUP D

- Polished Gold (8)
- Satin Gold (35)
- Antique Copper (36)
- Venezian Bronze (47)



4T-0663J

## 4-5/8" OD SNAP-IN STRAINER | 4T-0663J

FITS MUSTEE SHOWER PANS THAT USE PLASTIC SD

SERIES BASES

PRONG-TO-PRONG DIAMETER IS 3"

LENGTH IS 3/8"

# SNAP-IN STRAINERS

4T-077G & 4T-483



4T-077G

## 4-1/4" OD SNAP-IN STRAINER | 4T-077G

FITS CP INDUSTRIES SHOWER DRAIN AND SIOUX CHIEF 8262-P DRAIN

PRONG-TO-PRONG DIAMETER IS 2-13/16"

### 4T-077G

#### FINISHES & PRICE GROUPS:

##### PRICE GROUP A

- Polished Chrome (1)

##### PRICE GROUP B

- White (13)
- Gloss Black (15)
- Biscuit (16)
- Almond (19)
- Flat Black (20)

##### PRICE GROUP C

- Polished Brass & PVD (2)
- Antique Brass (3)
- Antique Nickel (Pewter) (4)
- Satin Chrome (6)
- Polished Nickel (30)
- Satin Nickel (31)
- Oil Rubbed Bronze (34)
- Stainless/Brushed Nickel (50)

##### PRICE GROUP D

- Polished Gold (8)
- Satin Gold (35)
- Light Brushed Bronze (38)



4T-483

## 3" FIT-ALL SNAP-IN STRAINER | 4T-483

FITS MOST 2" PIPES

PRONG LENGTH IS APPROX. 1-1/4"

### 4T-483

#### FINISHES & PRICE GROUPS:

##### PRICE GROUP A

- Polished Chrome (1)

##### PRICE GROUP B

- White (13)
- Flat Black (20)

##### PRICE GROUP C

- Polished Brass & PVD (2)
- Antique Brass (3)
- Antique Nickel (Pewter) (4)
- Satin Chrome (6)
- Satin Nickel (31)
- Oil Rubbed Bronze (34)
- Stainless/Brushed Nickel (50)

##### PRICE GROUP D

- Polished Copper (7)
- Satin Gold (35)



# SNAP-IN STRAINERS

4T-048 & 4T-480

## 4T-048

### FINISHES & PRICE GROUPS:

#### PRICE GROUP A

- Polished Chrome (1)

#### PRICE GROUP B

- White (13)

#### PRICE GROUP C

- Polished Brass & PVD (2)
- Antique Nickel (Pewter) (4)
- Satin Chrome (6)
- Satin Nickel (31)
- Oil Rubbed Bronze (34)
- Stainless/Brushed Nickel (50)

#### PRICE GROUP D

- Polished Copper (7)
- Antique Copper (36)



4T-048

## 4" FIT-ALL STRAINER | 4T-048

SNAP-IN, FITS MOST 3" PIPES

PRONG LENGTH IS APPROX. 1-1/4"

## 4T-480

### FINISHES & PRICE GROUPS:

#### PRICE GROUP A

- Polished Chrome (1)

#### PRICE GROUP C

- Polished Brass & PVD (2)
- Satin Chrome (6)
- Satin Nickel (31)
- Oil Rubbed Bronze (34)
- Stainless/Brushed Nickel (50)

#### PRICE GROUP D

- Polished Copper (7)



4T-480

## 5" FIT-ALL SNAP-IN STRAINER | 4T-480

FITS MOST 4" PIPES

PRONG LENGTH IS APPROX. 1-1/4"

# CROWNS

4T-032, 4T-042GC & 4T-046



4T-032

## 3-1/2" OD (3" ID) CROWN | 4T-032

FITS PLUMBING PRODUCTS, PASCO AND AMERICAN BRASS & ALUMINUM DRAINS



4T-042GC

## 3-5/8" OD (3" ID) CROWN | 4T-042GC

FITS OATEY DRAINS



4T-046

## 3-1/2" OD (2-7/8" ID) CROWN | 4T-046

FITS FRANK PATTERN (INSTANT SET) SHOWER DRAIN

### 4T-032 FINISHES & PRICE GROUPS:

#### PRICE GROUP A

- Polished Chrome (1)

#### PRICE GROUP B

- White (13)
- Gloss Black (15)
- Biscuit (16)
- Flat Black (20)

#### PRICE GROUP C

- Polished Brass & PVD (2)
- Antique Brass (3)
- Antique Nickel (Pewter) (4)
- Satin Brass (5)

- Satin Chrome (6)
- Polished Nickel (30)
- Satin Nickel (31)
- Oil Rubbed Bronze (34)
- Stainless/Brushed Nickel (50)

#### PRICE GROUP D

- Polished Gold (8)
- Antique Bronze (33)
- Satin Gold (35)
- Light Brushed Bronze (38)
- Aged Pewter (40)
- Veneizian Bronze (47)

### 4T-042GC & 4T-046 FINISHES & PRICE GROUPS:

#### PRICE GROUP A

- Polished Chrome (1)

#### PRICE GROUP B

- White (13)
- Gloss Black (15)
- Biscuit (16)
- Almond (19)
- Flat Black (20)

#### PRICE GROUP C

- Polished Brass & PVD (2)
- Antique Brass (3)
- Antique Nickel (Pewter) (4)
- Satin Brass (5)
- Satin Chrome (6)
- Polished Nickel (30)
- Satin Nickel (31)
- Oil Rubbed Bronze (34)
- Stainless/Brushed Nickel (50)

#### PRICE GROUP D

- Satin Gold (35)
- Light Brushed Bronze (38)
- Veneizian Bronze (47)

# SCREWS

4T-033, 4T-094 & 4T-095

## 4T-033

### FINISHES & PRICE GROUPS:

#### PRICE GROUP A

- Polished Chrome (1)

#### PRICE GROUP B

- White (13)
- Gloss Black (15)
- Biscuit (16)
- Almond (19)
- Flat Black (20)

#### PRICE GROUP C

- Polished Brass & PVD (2)
- Antique Brass (3)
- Antique Nickel (Pewter) (4)
- Satin Brass (5)
- Satin Chrome (6)
- Polished Nickel (30)
- Satin Nickel (31)
- Oil Rubbed Bronze (34)
- Stainless/Brushed Nickel (50)

#### PRICE GROUP D

- Polished Copper (7)
- Polished Gold (8)
- Antique Bronze (33)
- Satin Gold (35)
- Antique Copper (36)
- Light Brushed Bronze (38)
- Venezian Bronze (47)



4T-033

## 8-32 X 3/8" FLATHEAD MACHINE SCREW | 4T-033

REPLACEMENT SCREW FOR 4T-030 & 4T-034

SET OF TWO



4T-094

## 10-24 X 3/8" FLATHEAD MACHINE SCREW | 4T-094

REPLACEMENT SCREW FOR 4T-090

SET OF TWO

## 4T-094 & 4T-095

### FINISHES & PRICE GROUPS:

#### PRICE GROUP A

- Polished Chrome (1)

#### PRICE GROUP B

- White (13)
- Biscuit (16)
- Flat Black (20)

#### PRICE GROUP C

- Polished Brass & PVD (2)
- Antique Brass (3)
- Antique Nickel (Pewter) (4)
- Satin Brass (5)
- Satin Chrome (6)
- Polished Nickel (30)
- Satin Nickel (31)
- Oil Rubbed Bronze (34)
- Stainless/Brushed Nickel (50)

#### PRICE GROUP D

- Polished Copper (7)
- Polished Gold (8)
- Satin Gold (35)
- Light Brushed Bronze (38)
- Aged Pewter (40)
- Venezian Bronze (47)



4T-095

## 8 X 3/8" PHILLIPS FLAT HEAD SELF-TAPPING TYPE "A" SCREW | 4T-095

REPLACEMENT SCREW FOR 4T-090

SET OF TWO



# SHOWER DRAINS

4T-002, 4T-004, 4T-005, 4T-006, 4T-007 & 4T-5NC

ALL SHOWER DRAINS ARE FACTORY ASSEMBLED WITH 4T-030 DRAIN TRIM SET



1-1/2" IPS EZ TEST CAST IRON SHOWER DRAIN | 4T-002

4T-002



2" IPS EZ TEST CAST IRON SHOWER DRAIN | 4T-004

4T-004



2" CAULK CAST IRON SHOWER DRAIN | 4T-005

4T-005



2" QUICK CAULK CAST IRON SHOWER DRAIN | 4T-006

INCLUDES JIFFY SEAL (4T-2JQ)

4T-006



2" NO HUB DRAIN | 4T-007

NEOPRENE COUPLING NOT INCLUDED

4T-007



2" NO CAULK LOS ANGELES (L. A.)  
CODE CAST IRON SHOWER DRAIN  
4T-5NC

FOR CAST IRON, STEEL OR PLASTIC PIPE

4T-5NC

# SHOWER DRAINS

4T-502A, 4T-503P, 4T-020 & 4T-021

ALL SHOWER DRAINS ARE FACTORY ASSEMBLED WITH 4T-030 DRAIN TRIM SET

## 2" NO CAULK ABS GLUE ON SHOWER DRAIN | 4T-502A

LA CODE



4T-502A

## 2" NO CAULK PVC GLUE ON SHOWER DRAIN | 4T-503P

LA CODE



4T-503P

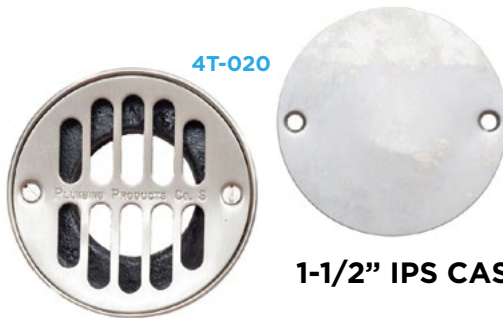

4T-020

## 1-1/2" IPS CAST IRON PROTECTION DRAIN | 4T-020

## 2" IPS CAST IRON PROTECTION DRAIN | 4T-021

4T-002, 4T-004, 4T-005, 4T-006, 4T-007, 4T-5NC, 4T-502A, 4T-503P, 4T-020 & 4T-021 FINISHES & PRICE GROUPS:

### PRICE GROUP A

- Polished Chrome (1)

### PRICE GROUP B

- White (13)
- Almond (19)
- Flat Black (20)

### PRICE GROUP C

- Polished Brass & PVD (2)
- Antique Brass (3)
- Antique Nickel (Pewter) (4)
- Satin Brass (5)
- Satin Chrome (6)

- Polished Nickel (30)
- Satin Nickel (31)
- Oil Rubbed Bronze (34)
- Stainless/Brushed Nickel (50)

### PRICE GROUP D

- Polished Gold (8)
- Light Gold (32)
- Antique Bronze (33)
- Satin Gold (35)
- Light Brushed Bronze (38)
- Aged Pewter (40)
- Venezian Bronze (47)



4T-021



# ROMAN TUB DRAINS

4T-055, 4T-062, 4T-064, 4T-065 & 4T-068

ALL THE ROMAN TUB DRAINS COME WITH THE 4T-055 DRAIN TOP



4T-055

## ROMAN TUB DRAIN TOP ONLY | 4T-055

INCLUDES CROWN (6CR) AND SCREWS (4T-056)



4T-062

## 1-1/2" IPS EZ TEST CAST IRON ROMAN TUB DRAIN | 4T-062



4T-064

## 2" IPS EZ TEST CAST IRON ROMAN TUB DRAIN | 4T-064



4T-065

## 2" CAULK CAST IRON ROMAN TUB DRAIN | 4T-065



4T-068

## 2" CAULK CAST IRON PROTECTION DRAIN FOR MARBLE TUBS | 4T-068

# ROMAN TUB DRAINS

4T-066A, 4T-5NCTD, 4T-067 & 4T-6420

ALL THE ROMAN TUB DRAINS COME WITH THE 4T-055 DRAIN TOP

## 2" QUICK CAULK CAST IRON W/ GASKET

### ROMAN TUB DRAIN | 4T-066A

RING NOT EXPOSED IN THIS INSTALLATION



4T-066A

## 2" NO CAULK CAST IRON LOS ANGELES CODE

### ROMAN TUB DRAIN | 4T-5NCTD

RING NOT EXPOSED IN THIS INSTALLATION



4T-5NCTD

## 2" NO HUB CAST IRON ROMAN TUB DRAIN | 4T-067

RING NOT EXPOSED IN THIS INSTALLATION



4T-067

4T-055, 4T-062, 4T-064,  
4T-065, 4T-068, 4T-066A,  
4T-5NCTD, 4T-067 & 4T-056

#### FINISHES & PRICE GROUPS:

##### PRICE GROUP A

- Polished Chrome (1)

##### PRICE GROUP B

- White (13)
- Flat Black (20)

##### PRICE GROUP C

- Polished Brass & PVD (2)
- Antique Brass (3)
- Antique Nickel (Pewter) (4)
- Satin Chrome (6)
- Polished Nickel (30)
- Satin Nickel (31)
- Oil Rubbed Bronze (34)
- Stainless/Brushed Nickel (50)

##### PRICE GROUP D

- Satin Gold (35)
- Light Brushed Bronze (38)
- Venezian Bronze (47)



4T-6420

## CHURCH OF LATTER-DAY SAINTS BAPTISMAL

### FONT DRAIN PACKAGE | 4T-6420

RING NOT EXPOSED IN THIS INSTALLATION

AVAILABLE IN **POLISHED CHROME ONLY**

#### PRICE GROUP A



### REPLACEMENT SCREWS FOR ROMAN TUB DRAINS

4T-056

TWO PER BAG



# TANK LEVERS

4T-190 & 4T-193



4T-190

## STANDARD TANK LEVER W/ 8" ARM | 4T-190

FITS MOST STANDARD TOILETS

FRONT MOUNT - LEFT SIDE



4T-193

## ARROW TANK LEVER W/ 8" ARM | 4T-193

FITS MOST STANDARD TOILETS

FRONT MOUNT - LEFT SIDE

### 4T-190 & 4T-193 FINISHES & PRICE GROUPS:

#### PRICE GROUP A

- Polished Chrome (1)

#### PRICE GROUP B

- White (13)
- Gloss Black (15)
- Biscuit (16)
- Almond (19)
- Flat Black (20)

#### PRICE GROUP C

- Polished Brass & PVD (2)
- Antique Brass (3)
- Antique Nickel (Pewter) (4)
- Satin Brass (5)
- Satin Chrome (6)
- Polished Nickel (30)
- Satin Nickel (31)

- Oil Rubbed Bronze (34)

- Stainless/Brushed Nickel (50)

#### PRICE GROUP D

- Polished Copper (7)
- Polished Gold (8)
- Light Gold (32)
- Antique Bronze (33)  
4T-193 only
- Satin Gold (35)  
4T-190 only
- Antique Copper (36)
- Light Brushed Bronze (38)  
4T-190 only
- Aged Pewter (40)
- Venezian Bronze (47)

# TANK LEVERS

4T-224 & 4T-225



## TANK LEVER FOR TOTO | 4T-224

FITS CARLYLE, CAROLINA, SUPREME, SUPREME ADA, ULTIMATE,  
ULTRAMAX, ADA, CST70414 AND CST704L14  
STRAIGHT ARM - SIDE MOUNT



## TANK LEVER FOR TOTO | 4T-225

FITS VESPIN, DRAKE AND DRAKE ADA  
CURVED ARM - SIDE MOUNT

### 4T-224 & 4T-225 FINISHES & PRICE GROUPS:

#### PRICE GROUP A

- Polished Chrome (1)

#### PRICE GROUP B

- White (13)
- Gloss Black (15)
- Almond (19)
- Flat Black (20)

#### PRICE GROUP C

- Polished Brass & PVD (2)
- Antique Brass (3)
- Antique Nickel (Pewter) (4)

- Satin Chrome (6)
- Polished Nickel (30)
- Satin Nickel (31)
- Oil Rubbed Bronze (34)
- Stainless/Brushed Nickel (50)

#### PRICE GROUP D

- Polished Gold (8)
- Light Gold (32)
- Satin Gold (35)
- Antique Copper (36)
- Light Brushed Bronze (38)

# TANK LEVERS

4T-194 & 4T-195



4T-194

## ANGLE MOUNT TANK LEVER | 4T-194

FITS KOHLER WELLWORTH II AND UNIVERSAL

RUNDLE ATHENS

### 4T-194

#### FINISHES & PRICE GROUPS:

##### PRICE GROUP A

- Polished Chrome (1)

##### PRICE GROUP B

- White (13)
- Gloss Black (15)
- Biscuit (16)
- Almond (19)
- Flat Black (20)

##### PRICE GROUP C

- Polished Brass & PVD (2)
- Antique Brass (3)
- Antique Nickel (Pewter) (4)
- Satin Brass (5)
- Satin Chrome (6)
- Polished Nickel (30)
- Satin Nickel (31)
- Oil Rubbed Bronze (34)
- Stainless/Brushed Nickel (50)

##### PRICE GROUP D

- Polished Gold (8)
- Light Gold (32)
- Antique Bronze (33)
- Satin Gold (35)
- Antique Copper (36)
- Aged Pewter (40)
- Venezian Bronze (47)

### 4T-195

#### FINISHES & PRICE GROUPS:

##### PRICE GROUP A

- Polished Chrome (1)

##### PRICE GROUP B

- Gloss Black (15)
- Flat Black (20)

##### PRICE GROUP C

- Polished Brass & PVD (2)
- Antique Nickel (Pewter) (4)
- Satin Chrome (6)
- Polished Nickel (30)
- Satin Nickel (31)
- Oil Rubbed Bronze (34)
- Stainless/Brushed Nickel (50)

##### PRICE GROUP D

- Polished Gold (8)
- Antique Bronze (33)



4T-195

## TANK LEVER W/ 8" ARM | 4T-195

FITS ELJER NEW EMBLEM

# TANK LEVERS, CLOSET TANK ELBOW & SLIP JOINT NUT

4T-196, 4T-197 & 4T-198

## 4T-196

### FINISHES & PRICE GROUPS:

#### PRICE GROUP A

- Polished Chrome (1)

#### PRICE GROUP B

- White (13)
- Gloss Black (15)
- Biscuit (16)
- Flat Black (20)

#### PRICE GROUP C

- Polished Brass & PVD (2)
- Antique Brass (3)
- Antique Nickel (Pewter) (4)
- Satin Brass (5)
- Satin Chrome (6)
- Polished Nickel (30)
- Satin Nickel (31)
- Oil Rubbed Bronze (34)
- Stainless/Brushed Nickel (50)

#### PRICE GROUP D

- Antique Bronze (33)
- Antique Copper (36)
- Aged Pewter (40)
- Venezian Bronze (47)



4T-196

## STANDARD TANK LEVER W/ 8" ARM | 4T-196

FITS MOST STANDARD TOILETS

FRONT MOUNT - LEFT SIDE



4T-198

## 2" X 2" SLIP JOINT NUT | 4T-198



4T-197

## CLOSET TANK ELBOW | 4T-197

INCLUDES 2 BRASS SLIP JOINT NUTS (4T-198)

AND WASHERS

MEASURES 2" X 6" X 8"

## 4T-197 & 4T-198

### FINISHES & PRICE GROUPS:

#### PRICE GROUP A

- Polished Chrome (1)

#### PRICE GROUP B

- White (13)
- Flat Black (20)

#### PRICE GROUP C

- Polished Brass & PVD (2)
- Antique Brass (3)
- Antique Nickel (Pewter) (4)
- Satin Brass (5)
- Polished Nickel (30)
- Satin Nickel (31)
- Oil Rubbed Bronze (34)
- Stainless/Brushed Nickel (50)

#### PRICE GROUP D

- Light Brushed Bronze (38)
- Aged Pewter (40)



# LAVATORY DRAINS

4T-245 & 4T-245L



4T-245

## MUSHROOM STYLE PLUG | 4T-245

- POP-UP STYLE
- PUSH TO SEAL/RELEASE
- HAS OVERFLOW HOLES
- 2.16" MUSHROOM PLATE

### 4T-245

#### FINISHES & PRICE GROUPS:

##### PRICE GROUP A

- Polished Chrome (1)

##### PRICE GROUP B

- White (13)
- Flat Black (20)

##### PRICE GROUP C

- Polished Brass & PVD (2)
- Antique Brass (3)
- Antique Nickel (Pewter) (4)
- Satin Brass (5)
- Polished Nickel (30)
- Satin Nickel (31)
- Oil Rubbed Bronze (34)
- Stainless/Brushed Nickel (50)

##### PRICE GROUP D

- Uncoated Polished Brass (11)
- Satin Gold (35)
- Antique Copper (36)
- Light Brushed Bronze (38)
- Venetian Bronze (47)

NEW

4T-245L



## MUSHROOM STYLE PLUG W/ LARGER PLATE | 4T-245L

- POP-UP STYLE
- PUSH TO SEAL/RELEASE
- HAS OVERFLOW HOLES
- 2.75" MUSHROOM PLATE

### 4T-245L

#### FINISHES & PRICE GROUPS:

##### PRICE GROUP A

- Polished Chrome (1)

##### PRICE GROUP B

- Flat Black (20)

##### PRICE GROUP C

- Polished Brass & PVD (2)
- Polished Nickel (30)
- Satin Nickel (31)
- Oil Rubbed Bronze (34)
- Stainless/Brushed Nickel (50)

##### PRICE GROUP D

- Light Brushed Bronze (38)

# LAVATORY DRAINS

4T-246 & 4T-246L

## 4T-246

### FINISHES & PRICE GROUPS:

#### PRICE GROUP A

- Polished Chrome (1)

#### PRICE GROUP B

- White (13)
- Gloss Black (15)
- Flat Black (20)

#### PRICE GROUP C

- Polished Brass & PVD (2)
- Antique Brass (3)
- Antique Nickel (Pewter) (4)
- Satin Brass (5)
- Polished Nickel (30)
- Satin Nickel (31)
- Oil Rubbed Bronze (34)
- Stainless/Brushed Nickel (50)

#### PRICE GROUP D

- Uncoated Polished Brass (11)
- Antique Bronze (33)
- Satin Gold (35)
- Antique Copper (36)
- Light Brushed Bronze (38)
- Venezian Bronze (47)

## MUSHROOM STYLE PLUG | 4T-246

POP-UP STYLE

PUSH TO SEAL/RELEASE

NO OVERFLOW HOLE

2.16" MUSHROOM PLATE



4T-246

## 4T-246L

### FINISHES & PRICE GROUPS:

#### PRICE GROUP A

- Polished Chrome (1)

#### PRICE GROUP B

- Flat Black (20)

#### PRICE GROUP C

- Polished Brass & PVD (2)
- Antique Brass (3)
- Satin Brass (5)
- Polished Nickel (30)
- Satin Nickel (31)
- Oil Rubbed Bronze (34)
- Stainless/Brushed Nickel (50)

#### PRICE GROUP D

- Satin Gold (35)
- Light Brushed Bronze (38)
- Venezian Bronze (47)

## MUSHROOM STYLE PLUG WITH LARGER PLATE

4T-246L

POP-UP STYLE

PUSH TO SEAL/RELEASE

NO OVERFLOW HOLE

LARGE MUSHROOM STYLE PLATE

2.75" DIAMETER

NEW



4T-246L

# LAVATORY DRAINS

4T-251 & 4T-251N



4T-251

## 2 PIECE PO PLUG GRID DRAIN | 4T-251

ALL PARTS ARE PLATED - HAS OVERFLOW HOLES

FITS 1-1/2" OPENING

TAILPIECE IS 1-1/4" OD X 8"



4T-251N

## 2 PIECE CO PLUG GRID DRAIN | 4T-251N

ALL PARTS ARE PLATED - NO OVERFLOW HOLES

FITS 1-1/2" OPENING

TAILPIECE IS 1-1/4" OD X 8"

### 4T-251 & 4T-251N FINISHES & PRICE GROUPS:

#### PRICE GROUP A

- Polished Chrome (1)

#### PRICE GROUP B

- White (13)
- Gloss Black (15)
- Flat Black (20)

#### PRICE GROUP C

- Polished Brass & PVD (2)
- Antique Brass (3)
- Antique Nickel (Pewter) (4)
- Satin Brass (5)
- Satin Chrome (6)
- Polished Nickel (30)
- Satin Nickel (31)

- Oil Rubbed Bronze (34)
- Stainless/Brushed Nickel (50)

#### PRICE GROUP D

- Polished Copper (7)
- Uncoated Polished Brass (11)
- Black Nickel (12)  
4T-251N only
- Antique Bronze (33)
- Satin Gold (35)
- Antique Copper (36)
- Satin Copper (37)
- Light Brushed Bronze (38)
- Aged Pewter (40)
- Venezian Bronze (47)

# LAVATORY DRAINS

4T-253 & 4T-253N

## 2 PIECE LIFT & TURN | 4T-253

ALL PARTS PLATED - HAS OVERFLOW HOLES

FITS 1-1/2" OPENING

TAILPIECE IS 1-1/4" OD X 8"



4T-253N

## 2 PIECE LIFT & TURN | 4T-253N

ALL PARTS PLATED - NO OVERFLOW HOLES

FITS 1-1/2" OPENING

TAILPIECE IS 1-1/4" OD X 8"

### 4T-253 & 4T-253N FINISHES & PRICE GROUPS:

#### PRICE GROUP A

- Polished Chrome (1)

#### PRICE GROUP B

- White (13)
- Flat Black (20)

#### PRICE GROUP C

- Polished Brass & PVD (2)
- Antique Brass (3)
- Antique Nickel (Pewter) (4)
- Satin Brass (5)
- Satin Chrome (6)
- Polished Nickel (30)

- Satin Nickel (31)
- Oil Rubbed Bronze (34)
- Stainless/Brushed Nickel (50)

#### PRICE GROUP D

- Uncoated Polished Brass (11)
- Antique Bronze (33)
- Satin Gold (35)
- Antique Copper (36)
- Satin Copper (37)
- 4T-253N only
- Light Brushed Bronze (38)
- Venezeian Bronze (47)



# LAVATORY DRAINS

4T-247 & 4T-249



4T-247

## POP-UP LAVATORY DRAIN ASSEMBLY | 4T-247

ALL VISIBLE PARTS ARE PLATED  
FITS 1-1/2" OPENING SIZE 1-1/4" OD X 8"  
HAS OVERFLOW HOLES



### 4T-247

#### FINISHES & PRICE GROUPS:

##### PRICE GROUP A

- Polished Chrome (1)

##### PRICE GROUP B

- White (13)
- Biscuit (16)
- Almond (19)
- Flat Black (20)

##### PRICE GROUP C

- Polished Brass & PVD (2)
- Antique Brass (3)
- Antique Nickel (Pewter) (4)
- Satin Brass (5)
- Satin Chrome (6)
- Polished Nickel (30)
- Satin Nickel (31)
- Oil Rubbed Bronze (34)
- Stainless/Brushed Nickel (50)

##### PRICE GROUP D

- Polished Gold (8)
- Uncoated Polished Brass (11)
- Satin Gold (35)
- Antique Copper (36)
- Light Brushed Bronze (38)
- Venezian Bronze (47)

### 4T-249

#### FINISHES & PRICE GROUPS:

##### PRICE GROUP A

- Polished Chrome (1)

##### PRICE GROUP B

- Flat Black (20)

##### PRICE GROUP C

- Polished Brass & PVD (2)
- Antique Brass (3)
- Antique Nickel (Pewter) (4)
- Satin Chrome (6)
- Polished Nickel (30)
- Satin Nickel (31)
- Oil Rubbed Bronze (34)
- Stainless/Brushed Nickel (50)

##### PRICE GROUP D

- Uncoated Polished Brass (11)
- Satin Gold (35)
- Antique Copper (36)

4T-249



## MUSHROOM STYLE FIXED CO PLUG

4T-249

STATIONARY - NON SEALING

NO OVERFLOW HOLES

2-3/4" DIAMETER PLATE

# LAVATORY DRAINS & VESSEL SPACER

4T-250 & 4T-701

## 4T-250

### FINISHES & PRICE GROUPS:

#### PRICE GROUP A

- Polished Chrome (1)

#### PRICE GROUP B

- Gloss Black (15)
- Almond (19)

#### PRICE GROUP C

- Polished Brass & PVD (2)
- Antique Brass (3)
- Polished Nickel (30)
- Satin Nickel (31)
- Oil Rubbed Bronze (34)

#### PRICE GROUP D

- Polished Copper (7)
- Satin Gold (35)
- Venezian Bronze (47)



## 1 PIECE PLUG | 4T-250

INCLUDES CHAIN & STOPPER (4T-175SC)

CRUMB CUP (4T-252) SIZE 1-1/4" OD X 6-1/4"

FITS 1-1/2" OPENING



## VESSEL SPACER | 4T-701

1-3/4" ID

4" OD X 11/16" TALL

## 4T-701

### FINISHES & PRICE GROUPS:

#### PRICE GROUP A

- Polished Chrome (1)

#### PRICE GROUP B

- White (13)
- Flat Black (20)

#### PRICE GROUP C

- Polished Brass & PVD (2)
- Antique Brass (3)
- Satin Brass (5)
- Satin Chrome (6)
- Polished Nickel (30)
- Satin Nickel (31)
- Oil Rubbed Bronze (34)
- Stainless/Brushed Nickel (50)

#### PRICE GROUP D

- Satin Gold (35)
- Antique Copper (36)
- Light Brushed Bronze (38)
- Aged Pewter (40)
- Venezian Bronze (47)

# P-TRAPS (17 GAUGE)

4T-254 & 4T-254K



4T-254

**1-1/4" X 1-1/4" P-TRAP | 4T-254**

INCLUDES 4T-259 FLANGE



4T-254K

**1-1/4" X 1-1/4" P-TRAP WITH 14" WALL BEND | 4T-254K**

INCLUDES 4T-259 FLANGE

## 4T-254 & 4T-254K FINISHES & PRICE GROUPS:

### PRICE GROUP A

- Polished Chrome (1)

### PRICE GROUP B

- White (13)
- Biscuit (16)
- Flat Black (20)

### PRICE GROUP C

- Polished Brass & PVD (2)
- Antique Brass (3)
- Antique Nickel (Pewter) (4)
- Satin Brass (5)
- Satin Chrome (6)
- Polished Nickel (30)
- Satin Nickel (31)
- Oil Rubbed Bronze (34)
- Stainless/Brushed Nickel (50)

### PRICE GROUP D

- Polished Copper (7)  
4T-254 only
- Polished Gold (8)  
4T-254 only
- Uncoated Polished Brass (11)
- Light Gold (32)  
4T-254 only
- Antique Bronze (33)
- Satin Gold (35)
- Antique Copper (36)
- Light Brushed Bronze (38)
- Aged Pewter (40)  
4T-254 only
- Venezian Bronze (47)

# P-TRAPS (17 GAUGE)

4T-2566, 4T-2566K & 4T-2551D

## 1-1/2" X 1-1/2" P-TRAP | 4T-2566

INCLUDES 4T-258 FLANGE



## 1-1/2" X 1-1/2" P-TRAP WITH 14" WALL BEND | 4T-2566K

INCLUDES 4T-258 FLANGE



## 1-1/2" X 1-1/4" REDUCED NUT P-TRAP | 4T-2551D

INCLUDES 4T-258 FLANGE



### 4T-2566, 4T-2566K & 4T-2551D FINISHES & PRICE GROUPS:

#### PRICE GROUP A

- Polished Chrome (1)

#### PRICE GROUP B

- Gloss Black (15)
- Flat Black (20)

#### PRICE GROUP C

- Polished Brass & PVD (2)
- Antique Brass (3)
- Antique Nickel (Pewter) (4)
- Satin Brass (5)
- Satin Chrome (6)
- Polished Nickel (30)

- Satin Nickel (31)
- Oil Rubbed Bronze (34)
- Stainless/Brushed Nickel (50)

#### PRICE GROUP D

- Uncoated Polished Brass (11)
- Satin Gold (35)
- Antique Copper (36)
- Light Brushed Bronze (38)
- Aged Pewter (40)
- 4T-2566 & 4T-2551D only
- Venezian Bronze (47)



# P-TRAPS (17 GAUGE)

4T-255D & 4T-2565



4T-255D

**1-1/2" X 1-1/4" REDUCED NECK P-TRAP | 4T-255D**

INCLUDES 4T-258 FLANGE



4T-2565

**1-1/4" X 1-1/4" P-TRAP W/ CLEANOUT | 4T-2565**

INCLUDES 4T-259 FLANGE

## 4T-255D & 4T-2565 FINISHES & PRICE GROUPS:

### PRICE GROUP A

- Polished Chrome (1)

### PRICE GROUP B

- White (13)
- Flat Black (20)

### PRICE GROUP C

- Polished Brass & PVD (2)
- Antique Brass (3)
- Satin Chrome (6)
- Polished Nickel (30)

- Satin Nickel (31)
- Oil Rubbed Bronze (34)
- Stainless/Brushed Nickel (50)

### PRICE GROUP D

- Uncoated Polished Brass (11)
- Satin Gold (35)
- Antique Copper (36)
- Light Brushed Bronze (38)  
4T-255D only
- Venezian Bronze (47)

# DECORATIVE BOTTLE TRAP

4T-2577



4T-2577

## 1-1/4" X 1-1/4" ROUND BRASS P-TRAP | 4T-2577

12" WALL ARM

ROUND WALL FLANGE & CLEANOUT

### 4T-2577

#### FINISHES & PRICE GROUPS:

##### PRICE GROUP A

- Polished Chrome (1)

##### PRICE GROUP B

- Flat Black (20)

##### PRICE GROUP C

- Polished Brass & PVD (2)
- Satin Brass (5)
- Polished Nickel (30)
- Satin Nickel (31)
- Oil Rubbed Bronze (34)
- Stainless/Brushed Nickel (50)

##### PRICE GROUP D

- Satin Gold (35)
- Light Brushed Bronze (38)

# S-TRAPS (17 GAUGE)

4T-3648, 4T-3649 & 4T-3650



4T-3648

## 1-1/4" X 1-1/4" 17 G S-TRAP | 4T-3648

INCLUDES

- FLANGE (4T-259)
- 2 SLIP JOINT NUTS (4T-300)
- 2 WASHERS (SJ7W)

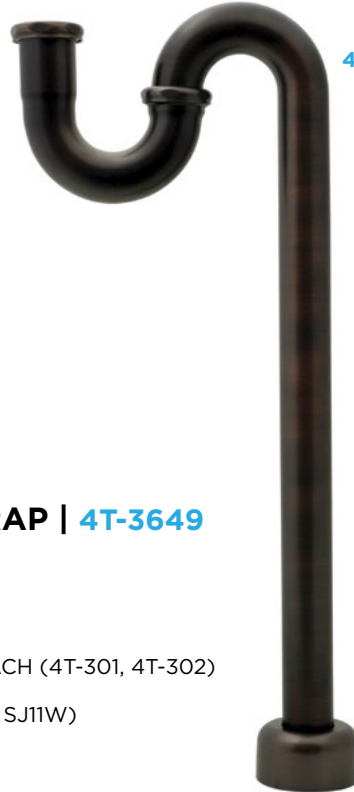

4T-3649

## 1-1/2" X 1-1/4" 17 G S-TRAP | 4T-3649

INCLUDES

- FLANGE (4T-258)
- TWO SLIP JOINT NUTS ONE EACH (4T-301, 4T-302)
- 2 WASHERS ONE EACH (SJ9W, SJ11W)

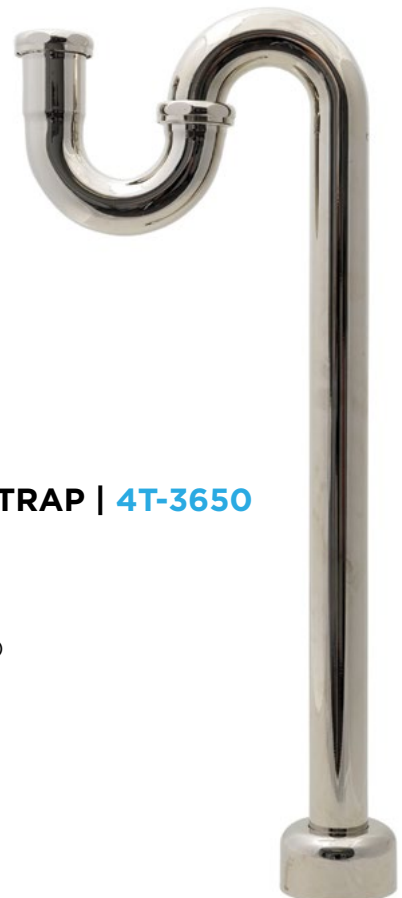

4T-3650

## 1-1/2" X 1-1/2" 17 G S-TRAP | 4T-3650

INCLUDES

- FLANGE (4T-258)
- 2 SLIP JOINT NUTS (4T-302)
- 2 WASHERS (SJ11W)

### 4T-3648, 4T-3649 & 4T-3650 FINISHES & PRICE GROUPS:

#### PRICE GROUP A

- Polished Chrome (1)

#### PRICE GROUP C

- Polished Brass & PVD (2)
- Polished Nickel (30)
- Satin Nickel (31)
- Oil Rubbed Bronze (34)
- Stainless/Brushed Nickel (50)

#### PRICE GROUP D

- Satin Gold (35)  
4T-3648 & 4T-3650 only
- Light Brushed Bronze (38)  
4T-3648 only

# SLIP JOINT EXTENSION TUBES

4T-267, 4T-267A, 4T-268 & 4T-268A

## 1-1/2" OD X 8" SLIP JOINT EXTENSION TUBE | 4T-267

NUT (4T-302)

WASHER (SJ11W)



4T-267

## 1-1/2" OD X 12" SLIP JOINT EXTENSION TUBE | 4T-267A

NUT (4T-302)

WASHER (SJ11W)



4T-267A

## 1-1/4" OD X 8" SLIP JOINT EXTENSION TUBE | 4T-268

NUT (4T-300)

WASHER (SJ7W)



4T-268

## 1-1/4" OD X 12" SLIP JOINT EXTENSION TUBE | 4T-268A

NUT (4T-300)

WASHER (SJ7W)



4T-268A

### 4T-267, 4T-267A, 4T-268 & 4T-268A FINISHES & PRICE GROUPS:

#### PRICE GROUP A

- Polished Chrome (1)

#### PRICE GROUP B

- Flat Black (20)

#### PRICE GROUP C

- Polished Brass & PVD (2)
- Antique Brass (3)
- Antique Nickel (Pewter) (4)
- Satin Brass (5)
- Satin Chrome (6)

- Polished Nickel (30)
- Satin Nickel (31)
- Oil Rubbed Bronze (34)
- Stainless/Brushed Nickel (50)

#### PRICE GROUP D

- Uncoated Polished Brass (11)
- Satin Gold (35)
- Antique Copper (36)
- Light Brushed Bronze (38)
- Venezian Bronze (47)



# TAILPIECES

4T-367, 4T-368, 4T-369, 4T-370 & 4T-371



4T-367

## FLANGED SINK TAILPIECE | 4T-367

1-1/2" OD X 8"



4T-368

## THREADED TAILPIECE | 4T-368

1-1/4" OD X 8"

THREADED ON BOTH ENDS



4T-369

## THREADED TAILPIECE | 4T-369

1-1/4" OD X 12"

THREADED ON BOTH ENDS



4T-370

## THREADED TAILPIECE | 4T-370

1-1/2" OD X 8"

THREADED ON BOTH ENDS



4T-371

## THREADED TAILPIECE | 4T-371

1-1/2" OD X 12"

THREADED ON BOTH ENDS

### 4T-367, 4T-368, 4T-369, 4T-370 & 4T-371

#### FINISHES & PRICE GROUPS:

##### PRICE GROUP A

- Polished Chrome (1)

##### PRICE GROUP B

- Flat Black (20)

##### PRICE GROUP C

- Polished Brass & PVD (2)
- Antique Brass (3)
- Satin Brass (5)
- Polished Nickel (30)

- Satin Nickel (31)

- Oil Rubbed Bronze (34)

- Stainless/Brushed Nickel (50)

##### PRICE GROUP D

- Uncoated Polished Brass (11)

- Satin Gold (35)

- 4T-367, 4T-368 & 4T-369 only

- Light Brushed Bronze (38)

- Venetian Bronze (47)

# SLIP JOINT ELBOWS

4T-628, 4T-629 & 4T-682

## 1-1/4" OD X 8" SLIP JOINT ELBOW | 4T-628

NUT (4T-300) AND WASHER (SJ7W)



4T-628

## 1-1/2" OD X 8" SLIP JOINT ELBOW | 4T-629

NUT (4T-302) AND WASHER (SJ11W)



4T-629

## 1-1/2" OD X 14" SLIP JOINT ELBOW | 4T-682

NUT (4T-302) AND WASHER (SJ11W)



4T-682

### 4T-628, 4T-629 & 4T-682 FINISHES & PRICE GROUPS:

#### PRICE GROUP A

- Polished Chrome (1)

#### PRICE GROUP B

- Flat Black (20)

#### PRICE GROUP C

- Polished Brass & PVD (2)
- Polished Nickel (30)

- Satin Nickel (31)

- Oil Rubbed Bronze (34)

- Stainless/Brushed Nickel (50)

#### PRICE GROUP D

- Uncoated Polished Brass (11)

# DOUBLE OFFSETS & SLIP JOINT NUTS

4T-630, 4T-631, 4T-300, 4T-301 & 4T-302

## 4T-630 & 4T-631 FINISHES & PRICE GROUPS:

### PRICE GROUP A

- Polished Chrome (1)

### PRICE GROUP B

- Flat Black (20)

### PRICE GROUP C

- Polished Brass & PVD (2)
- Antique Brass (3)
- Polished Nickel (30)
- Satin Nickel (31)
- Oil Rubbed Bronze (34)
- Stainless/Brushed Nickel (50)

### PRICE GROUP D

- Uncoated Polished Brass (11)
- Venezian Bronze (47)



4T-630

## 1-1/4" OD DOUBLE OFFSET | 4T-630

2 SLIP JOINT NUTS (4T-300)

2 NEOPRENE WASHERS

22 GAUGE

12" DOUBLE OFFSET



4T-631

## 1-1/2" OD DOUBLE OFFSET | 4T-631

2 SLIP JOINT NUTS (4T-302)

2 NEOPRENE WASHERS

22 GAUGE

12" DOUBLE OFFSET



4T-300

## 1-1/4" X 1-1/4" SLIP JOINT NUT | 4T-300

INCLUDES WASHER (SJ7W)



4T-301

## 1-1/2" X 1-1/4" SLIP JOINT NUT

4T-301

INCLUDES WASHER (SJ9W)



4T-302

## 1-1/2" X 1-1/2" SLIP JOINT NUT

4T-302

INCLUDES WASHER (SJ11W)

## 4T-300, 4T-301 & 4T-302 FINISHES & PRICE GROUPS:

### PRICE GROUP A

- Polished Chrome (1)

### PRICE GROUP B

- White (13)
- Gloss Black (15)
- Biscuit (16)
- Almond (19)
- Flat Black (20)

### PRICE GROUP C

- Polished Brass & PVD (2)
- Antique Brass (3)
- Antique Nickel (Pewter) (4)
- Satin Brass (5)
- Satin Chrome (6)
- Polished Nickel (30)

- Satin Nickel (31)

- Oil Rubbed Bronze (34)
- Stainless/Brushed Nickel (50)

### PRICE GROUP D

- Polished Copper (7)
- Uncoated Polished Brass (11)
- Black Nickel (12)
- Light Gold (32)
- Antique Bronze (33)
- Satin Gold (35)
- Antique Copper (36)
- Satin Copper (37)
- Light Brushed Bronze (38)
- Aged Pewter (40)
- Venezian Bronze (47)

# COVER CASINGS

4T-265, 4T-265A, 4T-265G, 4T-283 & 4T-283C

## 4T-265, 4T-265A & 4T-265G FINISHES & PRICE GROUPS:

### PRICE GROUP A

- Polished Chrome (1)

### PRICE GROUP C

- Polished Brass & PVD (2)
- Polished Nickel (30)
- Satin Nickel (31)
- Oil Rubbed Bronze (34)
- Stainless/Brushed Nickel (50)

## 2" OD X 10" COVER CASING

### 4T-265

COVERS 1-1/2" IPS

STEEL PIPE

BRASS BASE METAL

1-14/16" ID



## 2" OD X 6" COVER CASING | 4T-265A

BRASS BASE METAL

1-14/16" ID

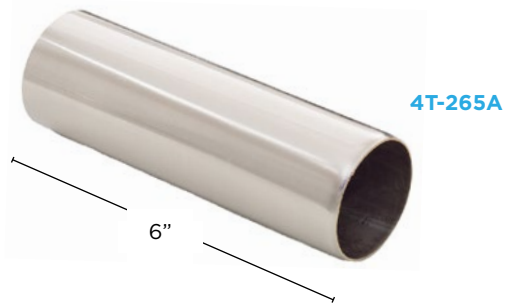

## 2" OD X 6" SINK FUNNEL | 4T-265G

BELL APPROXIMATELY 3-3/8" OD



## 4T-283, 4T-283C FINISHES & PRICE GROUPS:

### PRICE GROUP A

- Polished Chrome (1)

### PRICE GROUP B

- White (13)
- Gloss Black (15)
- Biscuit (16)
- Almond (19)
- Flat Black (20)

### PRICE GROUP C

- Polished Brass & PVD (2)
- Antique Brass (3)
- Antique Nickel (Pewter) (4)
- Satin Brass (5)
- Satin Chrome (6)
- Polished Nickel (30)
- Satin Nickel (31)
- Oil Rubbed Bronze (34)
- Stainless/Brushed Nickel (50)

### PRICE GROUP D

- Light Gold (32)
- Antique Bronze (33)
- Satin Gold (35)
- Antique Copper (36)
- 4T-283C only
- Light Brushed Bronze (38)
- Venezian Bronze (47)

## 15/16" OD X 10" COVER CASING

### 4T-283

FOR USE WITH STEEL PIPE

UNDER LAVATORY WHEN

PIPE EXTENDS FROM WALL

FITS OVER 1/2" IPS PIPE

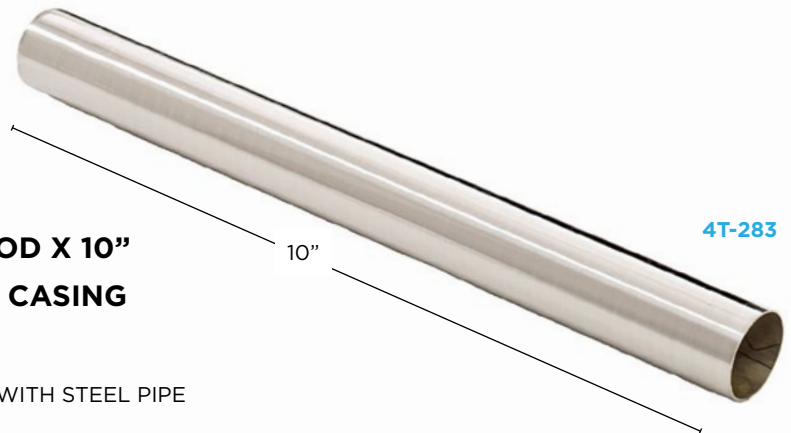

## 3-1/2" COVER TUBE | 4T-283C

FOR NOMINAL 1/2" COPPER TUBE



# BATH STRAINERS

4T-185, 4T-199X, 4T-335 & 4T-336



4T-185

## LIFT & TURN BATH PLUG | 4T-185

1-5/8" OD FINE THREAD (16 PER INCH)  
2-3/8" DIAMETER  
1-1/4" THREADS  
BUTTON RAISED 1/4"



4T-199X

## LIFT & TURN BATH PLUG | 4T-199X

4T-185 WITH REDUCING BUSHING (4T-186P) 1-1/2" OD  
1-5/8" OD - COARSE THREAD

4T-186P



4T-335 & 4T-336

## PUSH/PULL BATH PLUG | 4T-335

1-5/8" OD FINE THREAD  
16 THREADS PER INCH

## PUSH/PULL BATH PLUG W/ REDUCING BUSHING | 4T-336

4T-335 WITH REDUCING BUSHING (4T-186P) 1-1/2" OD  
1-5/8" OD COARSE THREAD

4T-186P



### 4T-185, 4T-199X, 4T-335 & 4T-336 FINISHES & PRICE GROUPS:

#### PRICE GROUP A

- Polished Chrome (1)

#### PRICE GROUP B

- White (13)
- Gloss Black (15)
- Biscuit (16)
- Almond (19)
- Flat Black (20)

#### PRICE GROUP C

- Polished Brass & PVD (2)
- Antique Brass (3)
- Antique Nickel (Pewter) (4)
- Satin Brass (5)
- Satin Chrome (6)
- Polished Nickel (30)

- Satin Nickel (31)
- Oil Rubbed Bronze (34)
- Stainless/Brushed Nickel (50)

#### PRICE GROUP D

- Polished Copper (7)  
4T-185 & 4T-199X only
- Polished Gold (8)
- Light Gold (32)
- Antique Bronze (33)
- Satin Gold (35)
- Antique Copper (36)
- Light Brushed Bronze (38)
- Aged Pewter (40)
- Venezeian Bronze (47)



# BATH STRAINERS

4T-1850A, 4T-1850B, 4T-187, 4T-1869 & 4T-1870

## TIP-TOE DRAIN STOPPER | 4T-1850A

1-5/8" OD - FINE THREAD (16 PER INCH)

## TIP-TOE DRAIN STOPPER W/ REDUCING BUSHING | 4T-1850B

4T-1850A WITH REDUCING BUSHING (4T-186P) 1-1/2" OD



4T-1850A & 4T-1850B

### 4T-1850A & 4T-1850B FINISHES & PRICE GROUPS:

#### PRICE GROUP A

- Polished Chrome (1)

#### PRICE GROUP B

- White (13)
- Biscuit (16)
- Almond (19)
- Flat Black (20)

#### PRICE GROUP C

- Polished Brass & PVD (2)
- Antique Brass (3)
- Antique Nickel (Pewter) (4)
- Satin Brass (5)

- Satin Chrome (6)
- Polished Nickel (30)
- Satin Nickel (31)
- Oil Rubbed Bronze (34)
- Stainless/Brushed Nickel (50)

#### PRICE GROUP D

- Antique Bronze (33)
- Satin Gold (35)
- Antique Copper (36)
- Light Brushed Bronze (38)
- Aged Pewter (40)
- Venezian Bronze (47)



4T-186P

## DOME STRAINER W/ SCREW | 4T-187

STRAINER (4T-1870) AND SCREW (4T-1869)

FITS GERBER STYLE STRAINER BODY

COUNTERSUNK CENTER HOLE FOR #10 OVAL SCREW (4T-1869)



4T-187 & 4T-1870

### 4T-187, 4T-1869 & 4T-1870 FINISHES & PRICE GROUPS:

#### PRICE GROUP A

- Polished Chrome (1)

#### PRICE GROUP B

- White (13)
- Gloss Black (15)
- Biscuit (16)
- Almond (19)
- Flat Black (20)

#### PRICE GROUP C

- Polished Brass & PVD (2)
- Antique Brass (3)
- Antique Nickel (Pewter) (4)
- Satin Brass (5)

- Satin Chrome (6)
- Polished Nickel (30)
- Satin Nickel (31)
- Oil Rubbed Bronze (34)
- Stainless/Brushed Nickel (50)

#### PRICE GROUP D

- Polished Copper (7)
- Light Gold (32)
- Antique Bronze (33)
- Satin Gold (35)
- Antique Copper (36)
- Light Brushed Bronze (38)
- Aged Pewter (40)
- Venezian Bronze (47)

## 2-7/8" OD DOME

## STRAINER ONLY | 4T-1870

COUNTERSUNK CENTER HOLE FOR (4T-1869)



4T-1869

## 10-24X 2" PHILLIPS OVAL HEAD 2" MACHINE SCREW | 4T-1869

REPLACEMENT SCREW FOR (4T-187) & (4T-1870)

# BATH STRAINERS

4T-183A, 4T-304 & 4T-1833



4T-183A & 4T-304

## BATHTUB STRAINER SET | 4T-183A

INCLUDES STRAINER BODY (4T-1833)

3-PRONG SNAP-IN STRAINER (4T-184)

## BATHTUB STRAINER SET W/ REDUCING BUSHING | 4T-304

4T-183A WITH 3-PRONG STRAINER (4T-184)

REDUCING BUSHING (4T-186P) COARSE THREAD (11-1/2 PER INCH)

FITS TUB WASTE & OVERFLOW WITH 1-1/2" SHOW



4T-186P



4T-1833

## 1-5/8" BATHTUB STRAINER BODY ONLY | 4T-1833

FINE THREAD (16 PER INCH)

### 4T-183A, 4T-304 & 4T-1833 FINISHES & PRICE GROUPS:

#### PRICE GROUP A

- Polished Chrome (1)

#### PRICE GROUP B

- White (13)
- Gloss Black (15)
- Biscuit (16)
- Almond (19)
- Flat Black (20)

#### PRICE GROUP C

- Polished Brass & PVD (2)
- Antique Brass (3)
- Antique Nickel (Pewter) (4)
- Satin Brass (5)
- Satin Chrome (6)
- Polished Nickel (30)

- Satin Nickel (31)
- Oil Rubbed Bronze (34)
- Stainless/Brushed Nickel (50)

#### PRICE GROUP D

- Polished Gold (8)
- Light Gold (32)  
4T-183A only
- Antique Bronze (33)
- Satin Gold (35)
- Antique Copper (36)
- Light Brushed Bronze (38)
- Aged Pewter (40)  
4T-183A only
- Venezian Bronze (47)

# TRIP LEVER DRAIN SET

4T-169



FLAT BLACK (20)

## TRIP LEVER DRAIN SET | 4T-169

INCLUDES DOME STRAINER SET (4T-187)

TRIP LEVER FACE PLATE WITH SCREWS (4T-170X)



STAINLESS/BRUSHED NICKEL (50)

### 4T-169 FINISHES & PRICE GROUPS:

#### PRICE GROUP A

- Polished Chrome (1)

#### PRICE GROUP B

- White (13)
- Gloss Black (15)
- Biscuit (16)
- Almond (19)
- Flat Black (20)

#### PRICE GROUP C

- Polished Brass & PVD (2)
- Antique Brass (3)
- Antique Nickel (Pewter) (4)
- Satin Brass (5)
- Satin Chrome (6)

- Polished Nickel (30)
- Satin Nickel (31)
- Oil Rubbed Bronze (34)
- Stainless/Brushed Nickel (50)

#### PRICE GROUP D

- Polished Copper (7)
- Light Gold (32)
- Antique Bronze (33)
- Satin Gold (35)
- Antique Copper (36)
- Light Brushed Bronze (38)
- Aged Pewter (40)
- Venezian Bronze (47)

# W & O CONVERSION KITS

4T-1900C, 4T-1900CB, 4T-1901C & 4T-1901CB



4T-1900C

## TRIP LEVER CONVERSION KIT W/ PLASTIC BUSHING | 4T-1900C

INCLUDES TRIP LEVER FACE PLATE W/ SCREWS (4T-170X)  
BATHTUB STRAINER (4T-183A)  
PLASTIC REDUCING BUSHING (4T-186P) 1-1/2" OD



4T-186P

## TRIP LEVER CONVERSION KIT W/BRASS BUSHING | 4T-1900CB

INCLUDES TRIP LEVER FACE PLATE W/ SCREWS (4T-170X)  
BATHTUB STRAINER (4T-183A)  
BRASS REDUCING BUSHING (4T-186) 1-1/2" OD



4T-186



4T-1901C

4T-186P

4T-186KP

## TRIP LEVER CONVERSION KIT W/ 2 BUSHINGS | 4T-1901C

INCLUDES TRIP LEVER FACE PLATE W/ SCREWS (4T-170X)  
BATHTUB STRAINER SET (4T-183A)  
2 PLASTIC REDUCING BUSHINGS (4T-186P, 4T-186KP)



4T-186K

## TRIP LEVER CONVERSION KIT W/ 2 BUSHINGS | 4T-1901CB

INCLUDES TRIP LEVER FACE PLATE W/ SCREWS (4T-170X)  
BATHTUB STRAINER SET (4T-183A)  
2 BRASS REDUCING BUSHINGS (4T-186, 4T-186K)



4T-186

### 4T-1900C, 4T-1900CB, 4T-1901C & 4T-1901CB FINISHES & PRICE GROUPS:

#### PRICE GROUP A

- Polished Chrome (1)

#### PRICE GROUP B

- White (13)
- Gloss Black (15)
- Biscuit (16)
- Almond (19)
- Flat Black (20)

#### PRICE GROUP C

- Polished Brass & PVD (2)
- Antique Brass (3)
- Antique Nickel (Pewter) (4)
- Satin Brass (5)
- Satin Chrome (6)
- Polished Nickel (30)
- Satin Nickel (31)
- Oil Rubbed Bronze (34)
- Stainless/Brushed Nickel (50)

#### PRICE GROUP D

- Polished Copper (7)
- Light Gold (32)
- Antique Bronze (33)
- Satin Gold (35)
- Antique Copper (36)
- Light Brushed Bronze (38)
- Aged Pewter (40)
- Venezian Bronze (47)

# W & O CONVERSION KITS

4T-1902C & 4T-1902CB

## LIFT & TURN CONVERSION KIT W/ PLASTIC BUSHING | 4T-1902C

INCLUDES 2-HOLE FACE PLATE & SCREWS (4T-174X)

BATH PLUG (4T-185)

PLASTIC REDUCING BUSHING (4T-186P) 1-1/2" OD



FLAT BLACK (20)



SATIN NICKEL (31)

### 4T-1902C & 4T-1902CB

#### FINISHES & PRICE GROUPS:

##### PRICE GROUP A

- Polished Chrome (1)

##### PRICE GROUP B

- White (13)
- Gloss Black (15)
- Biscuit (16)
- Almond (19)
- Flat Black (20)

##### PRICE GROUP C

- Polished Brass & PVD (2)
- Antique Brass (3)
- Antique Nickel (Pewter) (4)
- Satin Brass (5)
- Satin Chrome (6)
- Polished Nickel (30)
- Satin Nickel (31)
- Oil Rubbed Bronze (34)
- Stainless/Brushed Nickel (50)

##### PRICE GROUP D

- Light Gold (32)
- Antique Bronze (33)
- Satin Gold (35)
- Antique Copper (36)
- Light Brushed Bronze (38)
- Aged Pewter (40)
- Venezian Bronze (47)



## LIFT & TURN CONVERSION KIT W/ BRASS BUSHING | 4T-1902CB

INCLUDES 2-HOLE FACE PLATE & SCREWS (4T-174X)

BATH PLUG (4T-185)

BRASS REDUCING BUSHING (4T-186) 1-1/2" OD



# W & O CONVERSION KITS

4T-1903C, 4T-1903CB, 4T-1904C & 4T-1904CB

## TIP-TOE DRAIN CONVERSION KIT W/ PLASTIC BUSHING | 4T-1903C

INCLUDES 2-HOLE FACE PLATE & SCREWS (4T-174X)

TIP-TOE DRAIN (4T-1850A)

PLASTIC REDUCING BUSHING (4T-186P) 1-1/2" OD



4T-1903C & 4T-1903CB

## TIP-TOE DRAIN CONVERSION KIT W/ BRASS BUSHING | 4T-1903CB

INCLUDES 2-HOLE FACE PLATE & SCREWS (4T-174X)

TIP-TOE DRAIN (4T-1850A)

BRASS REDUCING BUSHING (4T-186) 1-1/2" OD



4T-186

## TIP-TOE CONVERSION KIT W/ PLASTIC BUSHING | 4T-1904C

INCLUDES 1- HOLE FACE PLATE W/ SCREWS (4T-173X)

TIP-TOE DRAIN (4T-1850A)

CONVERSION BAR (4T-171-KIT)

PLASTIC REDUCING BUSHING (4T-186P) 1-1/2" OD



4T-1904C & 4T-1904CB

4T-186

## TIP-TOE CONVERSION KIT W/ BRASS BUSHING | 4T-1904CB

INCLUDES 1- HOLE FACE PLATE W/ SCREWS (4T-173X), TIP-TOE DRAIN (4T-1850A),

CONVERSION BAR (4T-171-KIT) AND BRASS REDUCING BUSHING (4T-186) 1-1/2" OD

### 4T-1903C, 4T-1903CB, 4T-1904C & 4T-1904CB FINISHES & PRICE GROUPS:

#### PRICE GROUP A

- Polished Chrome (1)

#### PRICE GROUP B

- White (13)
- Biscuit (16)
- Almond (19)
- Flat Black (20)

#### PRICE GROUP C

- Polished Brass & PVD (2)
- Antique Brass (3)
- Antique Nickel (Pewter) (4)
- Satin Brass (5)
- Satin Chrome (6)
- Polished Nickel (30)
- Satin Nickel (31)
- Oil Rubbed Bronze (34)
- Stainless/Brushed Nickel (50)

#### PRICE GROUP D

- Antique Bronze (33)
- Satin Gold (35)
- Antique Copper (36)
- Light Brushed Bronze (38)
- Aged Pewter (40)
- Venezian Bronze (47)

# W & O CONVERSION KITS

4T-1905C & 4T-1905CB

## LIFT & TURN CONVERSION KIT W/ PLASTIC BUSHING | 4T-1905C

INCLUDES 1-HOLE FACE PLATE & SCREWS (4T-173X)

BATH PLUG (4T-185)

CONVERSION BAR (4T-171-KIT)

PLASTIC REDUCING BUSHING (4T-186P) 1-1/2" OD



## LIFT & TURN CONVERSION KIT W/ BRASS BUSHING 4T-1905CB

INCLUDES 1-HOLE FACE PLATE & SCREWS (4T-173X)

BATH PLUG (4T-185)

CONVERSION KIT (4T-171-KIT)

BRASS BUSHING (4T-186) 1-1/2" OD

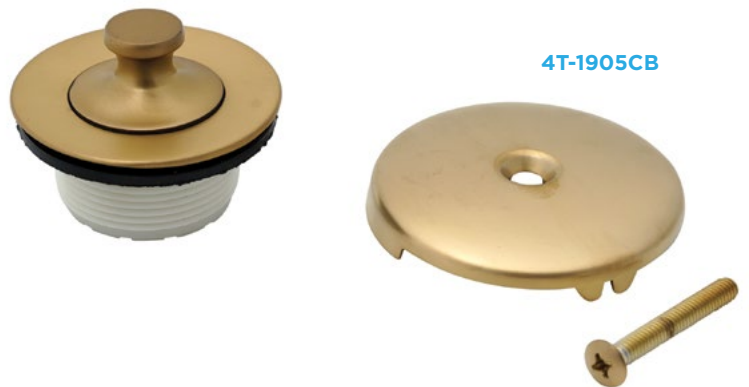

### 4T-1905C & 4T-1905CB FINISHES & PRICE GROUPS:

#### PRICE GROUP A

- Polished Chrome (1)

#### PRICE GROUP B

- White (13)
- Gloss Black (15)
- Biscuit (16)
- Almond (19)
- Flat Black (20)

#### PRICE GROUP C

- Polished Brass & PVD (2)
- Antique Brass (3)
- Antique Nickel (Pewter) (4)
- Satin Brass (5)
- Satin Chrome (6)

- Polished Nickel (30)

- Satin Nickel (31)
- Oil Rubbed Bronze (34)
- Stainless/Brushed Nickel (50)

#### PRICE GROUP D

- Polished Copper (7)
- Light Gold (32)
- Antique Bronze (33)
- Satin Gold (35)
- Antique Copper (36)
- Light Brushed Bronze (38)
- Aged Pewter (40)
- Venezian Bronze (47)



# W & O CONVERSION KITS

4T-1906C, 4T-1906CB, 4T-1907C & 4T-1907CB



4T-1906C

## PUSH/PULL CONVERSION KIT W/ PLASTIC BUSHING | 4T-1906C

INCLUDES 2-HOLE FACE PLATE (4T-174X)

BATH PLUG (4T-335)

PLASTIC REDUCING BUSHING (4T-186P) 1-1/2" OD



## PUSH/PULL CONVERSION KIT W/ BRASS BUSHING | 4T-1906CB

INCLUDES 2-HOLE FACE PLATE (4T-174X)

BATH PLUG (4T-335)

BRASS REDUCING BUSHING (4T-186) 1-1/2" OD



4T-1907C

4T-186



## PUSH/PULL CONVERSION KIT W/ PLASTIC BUSHING | 4T-1907C

INCLUDES 1-HOLE FACE PLATE (4T-173X)

BATH PLUG (4T-335)

CONVERSION BAR (4T-171-KIT)

PLASTIC REDUCING BUSHING (4T-186P) 1-1/2" OD

## PUSH/PULL CONVERSION KIT W/ BRASS BUSHING | 4T-1907CB

INCLUDES 1-HOLE FACE PLATE (4T-173X)

BATH PLUG (4T-335), CONVERSION BAR (4T-171-KIT)

BRASS REDUCING BUSHING (4T-186) 1-1/2" OD

4T-186

### 4T-1906C, 4T-1906CB, 4T-1907C & 4T-1907CB FINISHES & PRICE GROUPS:

#### PRICE GROUP A

- Polished Chrome (1)

#### PRICE GROUP B

- White (13)
- Biscuit (16)
- Almond (19)
- Flat Black (20)

#### PRICE GROUP C

- Polished Brass & PVD (2)
- Antique Brass (3)
- Antique Nickel (Pewter) (4)
- Satin Brass (5)
- Satin Chrome (6)
- Polished Nickel (30)
- Satin Nickel (31)
- Oil Rubbed Bronze (34)
- Stainless/Brushed Nickel (50)

#### PRICE GROUP D

- Light Gold (32)  
4T-170X & 4T-173X only
- Antique Bronze (33)
- Satin Gold (35)
- Antique Copper (36)
- Light Brushed Bronze (38)
- Aged Pewter (40)
- Venezian Bronze (47)

# FACE PLATES & ACCESSORIES

4T-170X, 4T-173X, 4T-174X & 4T-172

## TRIP LEVER STYLE FACE PLATE | 4T-170X

INCLUDES SCREWS (4T-172)

2" CENTER-TO-CENTER



## 1 HOLE FACE PLATE WITH SCREW | 4T-173X

INCLUDES SCREW (4T-172)

FOR USE WITH CHAIN & STOPPER

## 2 HOLE FACE PLATE WITH SCREWS | 4T-174X

INCLUDES SCREW (4T-172)

2" CENTER-TO-CENTER



### 4T-170X, 4T-173X, 4T-174X & 4T-172

#### FINISHES & PRICE GROUPS:

##### PRICE GROUP A

- Polished Chrome (1)

##### PRICE GROUP B

- White (13)
- Gloss Black (15)
- Biscuit (16)
- Almond (19)
- Flat Black (20)

##### PRICE GROUP C

- Polished Brass & PVD (2)
- Antique Brass (3)
- Antique Nickel (Pewter) (4)
- Satin Brass (5)
- Satin Chrome (6)
- Polished Nickel (30)
- Satin Nickel (31)
- Oil Rubbed Bronze (34)
- Stainless/Brushed Nickel (50)

##### PRICE GROUP D

- Polished Copper (7)
- Light Gold (32)
- Antique Bronze (33)
- Satin Gold (35)
- Antique Copper (36)
- Light Brushed Bronze (38)
- Aged Pewter (40)
- Venezian Bronze (47)



## 1/4"-20 X 1-1/2" BRASS OVAL HEAD MACHINE SCREW | 4T-172

COMPATIBLE WITH ALL STYLES OF FACEPLATES



## OVERFLOW BAR W/ 2 SCREWS | 4T-171-KIT

CONVERTS TWO HOLE APPLICATION TO ONE HOLE

PRICE GROUP A

# BUSHINGS

4T-186, 4T-186P, 4T-186K & 4T-186KP



4T-186

## REDUCING BUSHING IN ROUGH BRASS | 4T-186

ROUGH BRASS ONLY - REDUCES SHOE SIZE FROM 1-1/2" TO 1-3/8"

INTERIOR THREADS ARE FINE (16 PER INCH), 1-3/8" DIAMETER

EXTERIOR THREADS ARE COARSE (11-1/2 PER INCH)

1-1/2" DIAMETER

PRICE GROUP A



4T-186P

## PLASTIC REDUCING BUSHING | 4T-186P

REDUCES SHOE SIZE FROM 1-1/2" TO 1-3/8"

INTERIOR THREADS ARE FINE (16 PER INCH), 1-3/8" DIAMETER

EXTERIOR THREADS ARE COARSE (11-1/2 PER INCH)

1-1/2" DIAMETER

PRICE GROUP A



4T-186K

## REDUCING BUSHING IN ROUGH BRASS FOR KOHLER W & O 4T-186K

FITS KOHLER WASTE & OVERFLOW ITEMS - INTERIOR THREADS ARE COARSE (11-1/2 PER INCH)

EXTERIOR THREADS ARE FINE (16 PER INCH)

PRICE GROUP A



4T-186KP

## PLASTIC REDUCING BUSHING | 4T-186KP

FITS KOHLER WASTE & OVERFLOW ITEMS

INTERIOR THREADS ARE COARSE (11-1/2 PER INCH)

EXTERIOR THREADS ARE FINE (16 PER INCH)

PRICE GROUP A



# OFFSET BATH SUPPLIES

4T-188, 4T-189 & 4T-188K

## SINGLE OFFSET BATH SUPPLY | 4T-188

### INCLUDES

- SET OF TWO 1/2" OD RISERS
- 2 NUTS EACH (1/2", 3/4")
- 2 WASHERS (4T-106-AA, 4T-109-AA)
- 2 FRICTION RINGS EACH (4T-T105-AA, 4T-T108-AA)
- 2 FLANGES (4T-303)



## DOUBLE OFFSET BATH SUPPLY (SET OF 2) | 4T-189

### INCLUDES

- SET OF TWO 1/2" OD RISERS (4T-189L, 4T-189R)
- 2 NUTS EACH (1/2", 3/4")
- 2 WASHERS (4T-106-AA, 4T-109-AA)
- 2 FRICTION RINGS EACH (4T-T105-AA, 4T-T108-AA)
- 2 FLANGES (4T-303)



### 4T-188, 4T-189 & 4T-188K

#### FINISHES & PRICE GROUPS:

##### PRICE GROUP A

- Polished Chrome (1)

##### PRICE GROUP C

- Polished Brass & PVD (2)
- Polished Nickel (30)
- Satin Nickel (31)
- Oil Rubbed Bronze (34)
- Stainless/Brushed Nickel (50)

## REPLACEMENT KIT FOR OFFSET BATH SUPPLIES | 4T-188K

### INCLUDES

- 2 NUTS (1/2", 3/4")
- 2 WASHERS EACH (4T-106-AA, 4T-109-AA)
- 2 FRICTION RINGS EACH (4T-T105-AA, 4T-T108-AA)
- FOR USE WITH 4T-188 AND 4T-189

# W & O TRIP LEVER STYLE

4T-176X & 4T-177X



## 16" TRIP LEVER WASTE & OVERFLOW | 4T-176X

### INCLUDES

- FACE PLATE & SCREWS (4T-170X)
- BATHTUB STRAINER SET (4T-183A)
- MAXIMUM MAKEUP IS 16"
- 1-1/2" OD TUBULAR

## 22" TRIP LEVER WASTE & OVERFLOW | 4T-177X

### INCLUDES

- FACE PLATE & SCREWS (4T-170X)
- BATHTUB STRAINER SET (4T-183A)
- MAXIMUM MAKEUP IS 22"
- 1-1/2" OD TUBULAR

4T-176X & 4T-177X

### 4T-176X & 4T-177X FINISHES & PRICE GROUPS:

#### PRICE GROUP A

- Polished Chrome (1)

#### PRICE GROUP B

- White (13)
- Gloss Black (15)
- Biscuit (16)
- Almond (19)
- Flat Black (20)

#### PRICE GROUP C

- Polished Brass & PVD (2)
- Antique Brass (3)
- Antique Nickel (Pewter) (4)
- Satin Brass (5)

- Satin Chrome (6)
- Polished Nickel (30)
- Satin Nickel (31)
- Oil Rubbed Bronze (34)
- Stainless/Brushed Nickel (50)

#### PRICE GROUP D

- Light Gold (32)
- Antique Bronze (33)
- Satin Gold (35)
- Antique Copper (36)
- Light Brushed Bronze (38)
- Aged Pewter (40)
- Venezian Bronze (47)

# W & O TRIP LEVER STYLE

4T-1760X & 4T-9922D

## 16" TRIP LEVER WASTE & OVERFLOW FOR FREESTANDING TUBS | 4T-1760X

### INCLUDES

- FACE PLATE & SCREWS (4T-170X)
- BATHTUB STRAINER SET (4T-183A)
- FLANGE (4T-2588)
- EXPOSED PARTS ARE PLATED FOR FREESTANDING TUBS
- MAXIMUM MAKEUP IS 16"
- 1-1/2" OD TUBULAR

## 22" TRIP LEVER WASTE & OVERFLOW FOR FREESTANDING TUBS | 4T-9922D

### INCLUDES

- FACE PLATE & SCREWS (4T-170X)
- BATHTUB STRAINER SET (4T-183A)
- FLANGE (4T-2588)
- EXPOSED PARTS ARE PLATED FOR FREESTANDING TUBS
- MAXIMUM MAKEUP IS 22"
- 1-1/2" OD TUBULAR

### 4T-1760X & 4T-9922D

#### FINISHES & PRICE GROUPS:

##### PRICE GROUP A

- Polished Chrome (1)

##### PRICE GROUP B

- Flat Black (20)

##### PRICE GROUP C

- Polished Brass & PVD (2)
- Antique Brass (3)
- Satin Brass (5)
- Polished Nickel (30)
- Satin Nickel (31)
- Oil Rubbed Bronze (34)
- Stainless/Brushed Nickel (50)

##### PRICE GROUP D

- Satin Gold (35)
- Light Brushed Bronze (38)
- Venezian Bronze (47)



4T-1760X & 4T-9922D

# W & O LIFT & TURN STYLE

4T-178X & 4T-179X



4T-178X & 4T-179X

## 16" LIFT & TURN WASTE & OVERFLOW | 4T-178X

INCLUDES

- FACE PLATE & SCREWS (4T-174X)
- BATHTUB PLUG (4T-185)
- MAXIMUM MAKEUP IS 16"
- 1-1/2" OD TUBULAR

## 22" LIFT & TURN WASTE & OVERFLOW | 4T-179X

INCLUDES

- FACE PLATE & SCREWS (4T-174X)
- BATHTUB PLUG (4T-185)
- MAXIMUM MAKEUP IS 22"
- 1-1/2" OD TUBULAR

### 4T-178X & 179X FINISHES & PRICE GROUPS:

#### PRICE GROUP A

- Polished Chrome (1)

#### PRICE GROUP B

- White (13)
- Gloss Black (15)
- Biscuit (16)
- Almond (19)
- Flat Black (20)

#### PRICE GROUP C

- Polished Brass & PVD (2)
- Antique Brass (3)
- Antique Nickel (Pewter) (4)
- Satin Brass (5)
- Satin Chrome (6)

- Polished Nickel (30)
- Satin Nickel (31)
- Oil Rubbed Bronze (34)
- Stainless/Brushed Nickel (50)

#### PRICE GROUP D

- Polished Copper (7)
- Polished Gold (8)
- Light Gold (32)
- Antique Bronze (33)
- Satin Gold (35)
- Antique Copper (36)
- Light Brushed Bronze (38)
- Aged Pewter (40)
- Venezian Bronze (47)

# W & O LIFT & TURN STYLE

4T-7711D & 4T-7722D

## 16" LIFT & TURN WASTE & OVERFLOW FOR FREESTANDING TUBS | 4T-7711D

### INCLUDES

- FACE PLATE & SCREWS (4T-174X)
- BATH PLUG (4T-185)
- FLANGE (4T-2588)
- EXPOSED PARTS ARE PLATED FOR FREESTANDING TUBS
- MAXIMUM MAKEUP IS 16
- 1-1/2" OD TUBULAR

## 22" LIFT & TURN WASTE & OVERFLOW FOR FREESTANDING TUBS | 4T-7722D

### INCLUDES

- FACE PLATE & SCREWS (4T-174X)
- BATH PLUG (4T-185)
- FLANGE (4T-2588)
- EXPOSED PARTS ARE PLATED FOR FREESTANDING TUBS
- MAXIMUM MAKEUP IS 22"
- 1-1/2" OD TUBULAR



4T-7711D & 4T-7722D

### 4T-7711D & 4T-7722D

#### FINISHES & PRICE GROUPS:

##### PRICE GROUP A

- Polished Chrome (1)

##### PRICE GROUP B

- Flat Black (20)

##### PRICE GROUP C

- Polished Brass & PVD (2)
- Antique Brass (3)
- Satin Brass (5)
- Polished Nickel (30)
- Satin Nickel (31)
- Oil Rubbed Bronze (34)
- Stainless/Brushed Nickel (50)

##### PRICE GROUP D

- Satin Gold (35)
- Light Brushed Bronze (38)
- Venezian Bronze (47)



# W & O CHAIN & STOPPER

4T-1800A & 4T-9855D

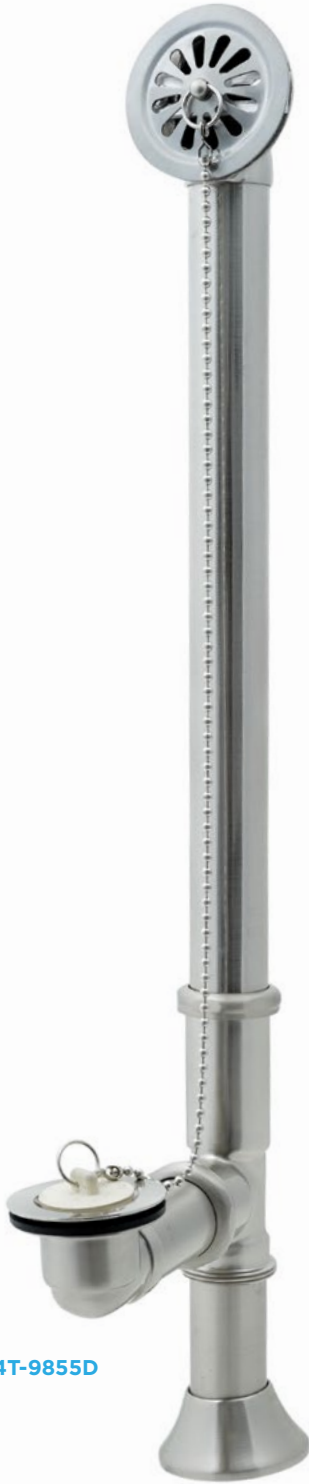

4T-1800A & 4T-9855D

## 16" CHAIN & STOPPER WASTE & OVERFLOW FOR FREESTANDING TUBS | 4T-1800A

### INCLUDES

- OVERFLOW SET (4T-175)
- STRAINER BODY (4T-1833) AND FLANGE (4T-2588)
- EXPOSED PARTS ARE PLATED FOR FREESTANDING TUBS
- MAXIMUM MAKEUP IS 16"
- 1-1/2" OD TUBULAR

## 22" CHAIN & STOPPER WASTE & OVERFLOW FOR FREESTANDING TUBS | 4T-9855D

### INCLUDES

- OVERFLOW SET (4T-175)
- STRAINER BODY (4T-1833)
- FLANGE (4T-2588)
- EXPOSED PARTS ARE PLATED FOR FREESTANDING TUBS
- MAXIMUM MAKEUP IS 22"
- 1-1/2" OD TUBULAR

### 4T-1800A & 4T-9855D

#### FINISHES & PRICE GROUPS:

##### PRICE GROUP A

- Polished Chrome (1)

##### PRICE GROUP B

- Flat Black (20)

##### PRICE GROUP C

- Polished Brass & PVD (2)
- Antique Brass (3)
- Satin Brass (5)
- Satin Nickel (31)
- Oil Rubbed Bronze (34)
- Stainless/Brushed Nickel (50)

##### PRICE GROUP D

- Venezian Bronze (47)

# W & O TIP-TOE STYLE

4T-1802A & 4T-1803A

## 16" TIP-TOE WASTE & OVERFLOW | 4T-1802A

### INCLUDES

- FACE PLATE (4T-174X)
- TIP-TOE DRAIN (4T-1850A)
- 1-1/2" OD TUBULAR
- MAXIMUM MAKE UP IS 16"

## 22" TIP-TOE WASTE & OVERFLOW | 4T-1803A

### INCLUDES

- FACE PLATE (4T-174X)
- TIP-TOE DRAIN (4T-1850A)
- 1-1/2" OD TUBULAR
- MAXIMUM MAKE UP IS 22"

### 4T-1802A & 4T-1803A

#### FINISHES & PRICE GROUPS:

##### PRICE GROUP A

- Polished Chrome (1)

##### PRICE GROUP B

- White (13)
- Biscuit (16)
- Almond (19)
- Flat Black (20)

##### PRICE GROUP C

- Polished Brass & PVD (2)
- Antique Brass (3)
- Antique Nickel (Pewter) (4)
- Satin Brass (5)
- Satin Chrome (6)
- Polished Nickel (30)
- Satin Nickel (31)
- Oil Rubbed Bronze (34)
- Stainless/Brushed Nickel (50)

##### PRICE GROUP D

- Antique Bronze (33)
- Satin Gold (35)
- Antique Copper (36)
- Light Brushed Bronze (38)
- Aged Pewter (40)
- Venezian Bronze (47)



4T-1802A & 4T-1803A

# W & O TIP-TOE STYLE

4T-1804A & 4T-1805A



## 16" TIP-TOE WASTE & OVERFLOW FOR FREESTANDING TUBS | 4T-1804A

### INCLUDES

- FACE PLATE (4T-174X)
- FLANGE (4T-2588)
- TIP-TOE DRAIN (4T-1850A)
- 1-1/2" OD TUBULAR
- EXPOSED PARTS ARE PLATED FOR FREESTANDING TUBS
- MAXIMUM MAKE UP IS 16"

## 22" TIP-TOE WASTE & OVERFLOW FOR FREESTANDING TUBS | 4T-1805A

### INCLUDES

- FACE PLATE (4T-174X)
- FLANGE (4T-2588)
- TIP-TOE DRAIN (4T-1850A)
- 1-1/2" OD TUBULAR
- EXPOSED PARTS ARE PLATED FOR FREESTANDING TUBS
- MAXIMUM MAKE UP IS 22"

4T-1804A & 4T-1805A

### 4T-1804A & 4T-1805A

#### FINISHES & PRICE GROUPS:

##### PRICE GROUP A

- Polished Chrome (1)

##### PRICE GROUP B

- Flat Black (20)

##### PRICE GROUP C

- Polished Brass & PVD (2)
- Antique Brass (3)
- Satin Brass (5)
- Polished Nickel (30)
- Satin Nickel (31)
- Oil Rubbed Bronze (34)
- Stainless/Brushed Nickel (50)

##### PRICE GROUP D

- Satin Gold (35)
- Light Brushed Bronze (38)
- Venezian Bronze (47)

# W & O TIP-TOE STYLE

4T-1833A | Extended Shoe Tube-9-1/2"

## 22" TIP-TOE WASTE & OVERFLOW WITH EXTENDED SHOE TUBE | 4T-1833A

### INCLUDES:

- TWO HOLE PLATE & SCREWS (4T-174X)
- TIP-TOE DRAIN (4T-1850A)
- 1-1/2" TUBULAR
- MAXIMUM MAKEUP IS 22"



4T-1833A

### 4T-1833A

#### FINISHES & PRICE GROUPS:

##### PRICE GROUP A

- Polished Chrome (1)

##### PRICE GROUP B

- White (13)
- Biscuit (16)
- Almond (19)
- Flat Black (20)

##### PRICE GROUP C

- Polished Brass & PVD (2)
- Antique Brass (3)
- Antique Nickel (Pewter) (4)
- Satin Brass (5)
- Satin Chrome (6)
- Polished Nickel (30)
- Satin Nickel (31)
- Oil Rubbed Bronze (34)
- Stainless/Brushed Nickel (50)

##### PRICE GROUP D

- Antique Bronze (33)
- Satin Gold (35)
- Antique Copper (36)
- Light Brushed Bronze (38)
- Aged Pewter (40)
- Venezian Bronze (47)

# 22" LIFT & TURN WASTE & OVERFLOW FOR FREESTANDING TUBS

4T-5599 | EXTENDED SHOE TUBE-9-1/2"



## 22" LIFT & TURN WASTE & OVERFLOW FOR FREESTANDING TUBS | 4T-5599

### INCLUDES

- TWO HOLE FACE PLATE & SCREWS (4T-174X)
- LIFT & TURN BATH PLUG (4T-185)
- FLANGE (4T-2588)
- EXPOSED PARTS ARE PLATED FOR FREESTANDING TUBS
- MAXIMUM MAKEUP IS 22"
- 1-1/2" OD TUBULAR

### 4T-5599

#### FINISHES & PRICE GROUPS:

##### PRICE GROUP A

- Polished Chrome (1)

##### PRICE GROUP B

- Flat Black (20)

##### PRICE GROUP C

- Polished Brass & PVD (2)
- Satin Brass (5)
- Polished Nickel (30)
- Satin Nickel (31)
- Oil Rubbed Bronze (34)
- Stainless/Brushed Nickel (50)

##### PRICE GROUP D

- Satin Gold (35)
- Light Brushed Bronze (38)



# 22" LIFT & TURN WASTE & OVERFLOW FOR FREESTANDING TUBS

4T-5599E | EXTENDED SHOE TUBE-18"

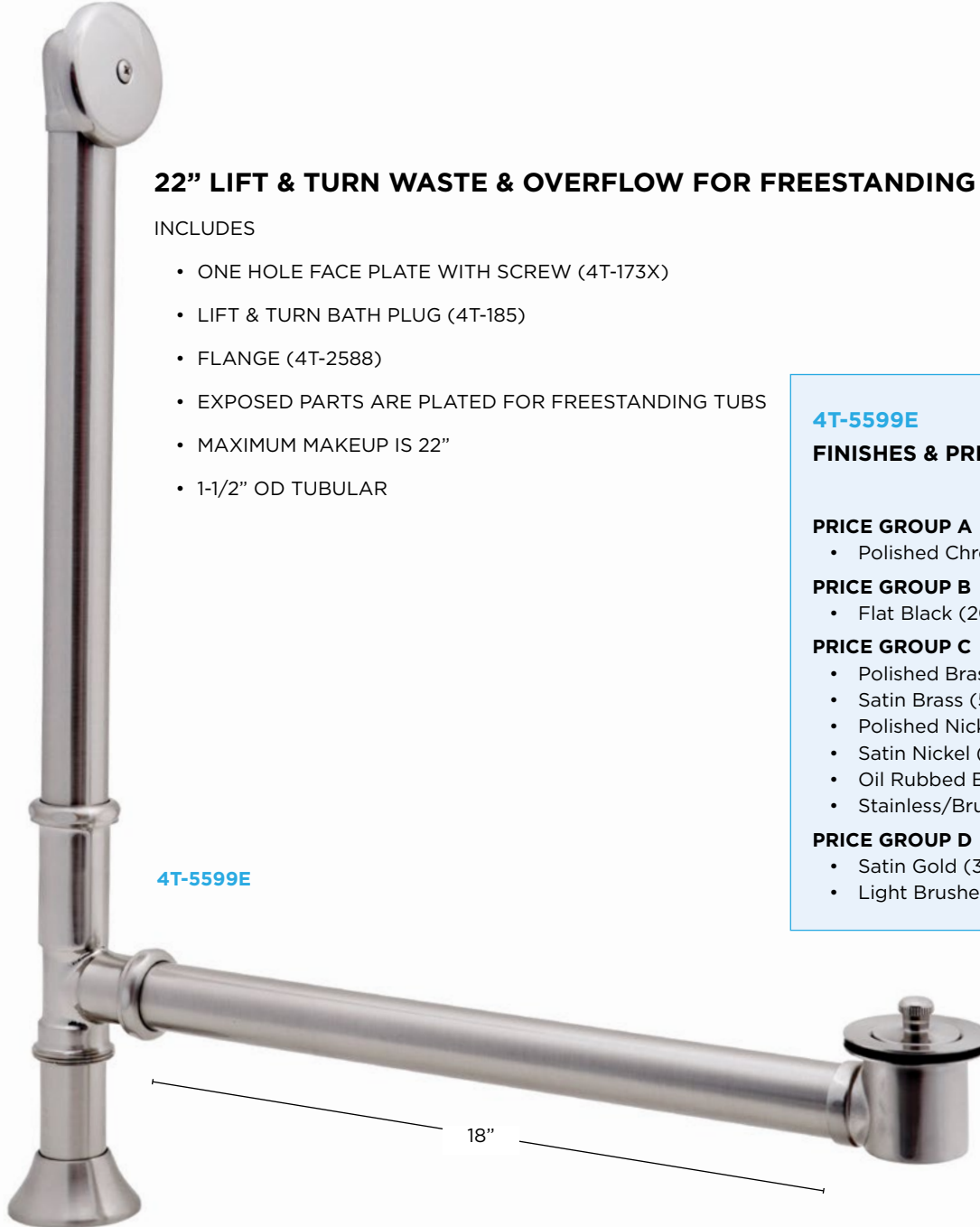

## 22" LIFT & TURN WASTE & OVERFLOW FOR FREESTANDING TUBS | 4T-5599E

### INCLUDES

- ONE HOLE FACE PLATE WITH SCREW (4T-173X)
- LIFT & TURN BATH PLUG (4T-185)
- FLANGE (4T-2588)
- EXPOSED PARTS ARE PLATED FOR FREESTANDING TUBS
- MAXIMUM MAKEUP IS 22"
- 1-1/2" OD TUBULAR

### 4T-5599E

#### FINISHES & PRICE GROUPS:

##### PRICE GROUP A

- Polished Chrome (1)

##### PRICE GROUP B

- Flat Black (20)

##### PRICE GROUP C

- Polished Brass & PVD (2)
- Satin Brass (5)
- Polished Nickel (30)
- Satin Nickel (31)
- Oil Rubbed Bronze (34)
- Stainless/Brushed Nickel (50)

##### PRICE GROUP D

- Satin Gold (35)
- Light Brushed Bronze (38)

4T-5599E

18"

# 1-1/2" TUBES FOR W & O

4T-1773A, 4T-1774A, 4T-1775A, 4T-1776A & 4T-1777A



**1-1/2" OD X 3" OVERFLOW TUBE | 4T-1773A**

THREADED AT ONE END

4T-1773A

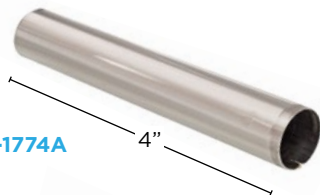

**1-1/2" OD X 4" OVERFLOW TUBE | 4T-1774A**

THREADED AT ONE END

4T-1774A

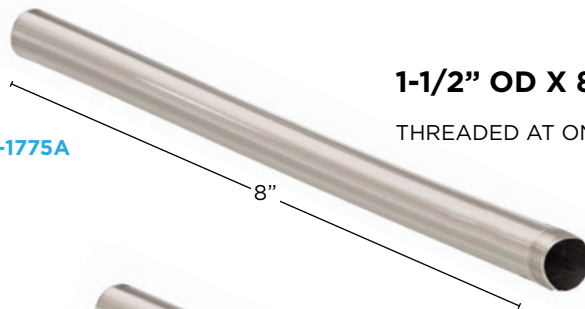

**1-1/2" OD X 8" OVERFLOW TUBE | 4T-1775A**

THREADED AT ONE END

4T-1775A



**1-1/2" OD X 9-1/2" OVERFLOW TUBE | 4T-1776A**

THREADED AT ONE END

4T-1776A

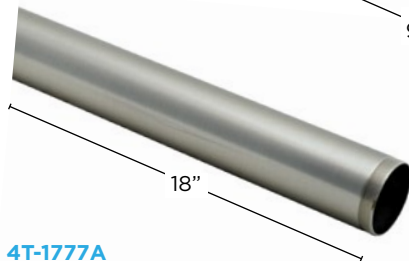

**1-1/2" OD X 18" OVERFLOW TUBE | 4T-1777A**

THREADED AT ONE END

4T-1777A

## 4T-1773A, 4T-1774A, 4T-1775A, 4T-1776A & 4T-1777A

### FINISHES & PRICE GROUPS:

#### PRICE GROUP A

- Polished Chrome (1)

#### PRICE GROUP B

- Flat Black (20)

#### PRICE GROUP C

- Polished Brass & PVD (2)
- Antique Brass (3)
- Satin Brass (5)

- Polished Nickel (30)

- Satin Nickel (31)

- Oil Rubbed Bronze (34)

- Stainless/Brushed Nickel (50)

#### PRICE GROUP D

- Satin Gold (35)

- Light Brushed Bronze (38)

- Venezian Bronze (47)

# 1-3/8" TUBES FOR W & O

4T-1779A, 4T-1780A, 4T-1781A, 4T-1782A & 4T-1783A

## 1-3/8" OD X 3" OVERFLOW | 4T-1779A

THREADED AT ONE END

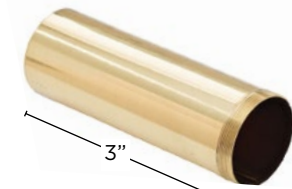

4T-1779A

## 1-3/8" OD X 4" OVERFLOW TUBE | 4T-1780A

THREADED AT ONE END

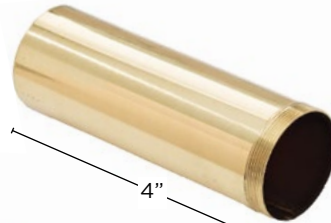

4T-1780A

## 1-3/8" OD X 8" OVERFLOW TUBE | 4T-1781A

THREADED AT ONE END

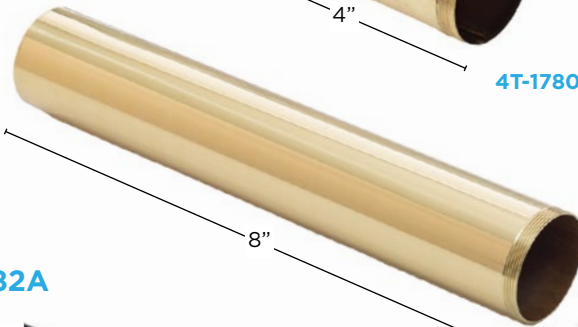

4T-1781A

## 1-3/8" OD X 12" OVERFLOW TUBE | 4T-1782A

THREADED AT ONE END



4T-1782A

## 1-3/8" OD X 18" OVERFLOW TUBE | 4T-1783A

THREADED AT ONE END



4T-1783A

4T-1779A, 4T-1780A, 4T-1781A,  
4T-1782A & 4T-1783A

### FINISHES & PRICE GROUPS:

#### PRICE GROUP A

- Polished Chrome (1)

#### PRICE GROUP C

- Polished Brass & PVD (2)

# ADJUSTABLE SHOWER ROD & HOLDER

4T-1020

NEW

## TWO-PIECE ADJUSTABLE SHOWER ROD | 4T-1020

STAINLESS STEEL TWO-PIECE ROD IS ADJUSTABLE FROM 43"-72"

COMES WITH TWO FLANGES AS SHOWN



4T-1020



### 4T-1020

#### FINISHES & PRICE GROUPS:

##### PRICE GROUP A

- Polished Chrome (1)

##### PRICE GROUP B

- Flat Black (20)

##### PRICE GROUP C

- Polished Brass & PVD (2)
- Satin Brass (5)
- Polished Nickel (30)
- Satin Nickel (31)
- Oil Rubbed Bronze (34)
- Stainless/Brushed Nickel (50)

##### PRICE GROUP D

- Satin Gold (35)
- Light Brushed Bronze (38)

# ONE PIECE SHOWER RODS

4T-1060, 4T-1072 & 4T-1090

NEW

## ONE-PIECE 60" STAINLESS STEEL SHOWER ROD | 4T-1060

1" DIAMETER

ROD ONLY, HOLDERS SOLD SEPARATELY



4T-1060

### 4T-1060 & 4T-1072

#### FINISHES & PRICE GROUP

##### PRICE GROUP A

- Polished Chrome (1)

##### PRICE GROUP B

- Flat Black (20)

##### PRICE GROUP C

- Polished Brass & PVD (2)
- Satin Brass (5)
- Polished Nickel (30)
- Satin Nickel (31)
- Oil Rubbed Bronze (34)
- Stainless/Brushed Nickel (50)

##### PRICE GROUP D

- Satin Gold (35)
- Light Brushed Bronze (38)

NEW

## ONE-PIECE 72" STAINLESS STEEL SHOWER ROD | 4T-1072

1" DIAMETER

ROD ONLY, HOLDERS SOLD SEPARATELY



4T-1072

## ONE-PIECE 6' BRASS SHOWER ROD | 4T-1090

1" DIAMETER

ROD ONLY, HOLDERS SOLD SEPARATELY



4T-1090

### 4T-1090

#### FINISHES & PRICE GROUPS:

##### PRICE GROUP A

- Polished Chrome (1)

##### PRICE GROUP B

- White (13)
- Gloss Black (15)
- Biscuit (16)
- Almond (19)
- Flat Black (20)

##### PRICE GROUP C

- Polished Brass & PVD (2)
- Antique Brass (3)
- Antique Nickel (Pewter) (4)

- Satin Brass (5)
- Satin Chrome (6)
- Polished Nickel (30)
- Satin Nickel (31)
- Oil Rubbed Bronze (34)
- Stainless/Brushed Nickel (50)

##### PRICE GROUP D

- Satin Gold (35)
- Antique Copper (36)
- Satin Copper (37)
- Light Brushed Bronze (38)
- Aged Pewter (40)



# SHOWER ROD FLANGES

4T-1190 & 4T-1150

NEW

## SOLID BRASS DECORATIVE ROD FLANGES | 4T-1190

SET OF TWO

FITS ALL 1" DIAMETER SHOWER RODS



4T-1190

### 4T-1190 & 4T-1150 FINISHES & PRICE GROUPS:

#### PRICE GROUP A

- Polished Chrome (1)

#### PRICE GROUP B

- Flat Black (20)

#### PRICE GROUP C

- Satin Brass (5)
- Satin Nickel (31)
- Oil Rubbed Bronze (34)
- Stainless/Brushed Nickel (50)

#### PRICE GROUP D

- Light Brushed Bronze (38)

## DIE CAST ROUND HEAVY DUTY SHOWER ROD FLANGES | 4T-1150

SET OF TWO

FITS ALL 1" DIAMETER SHOWER RODS

COMES WITH TWO DECORATIVE SCREWS AND DRYWALL ANCHORS



4T-1150

# SHOWER ROD HOLDERS & ACCESSORIES

4T-1160, 4T-1170, 4T-119 & 4T-112

## SHOWER ROD FLANGE SET WITH CONCEALED SCREWS | 4T-1160

INCLUDES 2 FLANGES

2 BRACKETS (PF16-AA) AND UNPLATED SCREWS



4T-1160

4T-1170



## SHOWER ROD FLANGE SET WITH EXPOSED SCREWS | 4T-1170

INCLUDES 2 FLANGES AND PLATED SCREWS

## SHOWER CURTAIN PIN SET | 4T-119

PACKAGED 12 PINS PER BAG



4T-119

## ADJUSTABLE ROD HOLDER SET | 4T-112



### 4T-112 FINISHES & PRICE GROUPS:

#### PRICE GROUP A

- Polished Chrome (1)

#### PRICE GROUP B

- White (13)
- Gloss Black (15)
- Biscuit (16)
- Almond (19)
- Flat Black (20)

#### PRICE GROUP C

- Polished Brass & PVD (2)
- Antique Brass (3)
- Satin Chrome (6)
- Polished Nickel (30)
- Satin Nickel (31)
- Oil Rubbed Bronze (34)
- Stainless/Brushed Nickel (50)

#### PRICE GROUP D

- Light Brushed Bronze (38)
- Venezian Bronze (47)

### 4T-1160, 4T-1170 & 4T-119

#### FINISHES & PRICE GROUPS:

##### PRICE GROUP A

- Polished Chrome (1)

##### PRICE GROUP B

- White (13)
- Gloss Black (15)
- Biscuit (16)
- Flat Black (20)

##### PRICE GROUP C

- Polished Brass & PVD (2)
- Antique Brass (3)
- Antique Nickel (Pewter) (4)
- Satin Brass (5)

- Satin Chrome (6)

- Polished Nickel (30)

- Satin Nickel (31)

- Oil Rubbed Bronze (34)

- Stainless/Brushed Nickel (50)

##### PRICE GROUP D

- Antique Copper (36)

- Satin Copper (37)

- Light Brushed Bronze (38)

- Aged Pewter (40)

- Venezian Bronze (47)

4T-119 only

# BRASS SHOWER HEADS

4T-121, 4T-122 & 4T-141



4T-121

## BRASS SHOWER HEAD | 4T-121

2-1/4" DIAMETER FACE WITH FLOW RESTRICTOR

### 4T-121 FINISHES & PRICE GROUPS:

#### PRICE GROUP A

- Polished Chrome (1)

#### PRICE GROUP B

- White (13)

#### PRICE GROUP C

- Polished Brass & PVD (2)
- Antique Brass (3)
- Polished Nickel (30)
- Satin Nickel (31)
- Oil Rubbed Bronze (34)
- Stainless/Brushed Nickel (50)



4T-122

## 6 SHOWER JET BRASS SHOWER HEAD | 4T-122

2-3/4" DIAMETER FACE WITH FLOW RESTRICTOR

### 4T-122 FINISHES & PRICE GROUPS:

#### PRICE GROUP A

- Polished Chrome (1)

#### PRICE GROUP B

- Flat Black (20)

#### PRICE GROUP C

- Polished Brass & PVD (2)
- Antique Brass (3)
- Satin Chrome (6)
- Satin Nickel (31)
- Oil Rubbed Bronze (34)
- Stainless/Brushed Nickel (50)

#### PRICE GROUP D

- Antique Bronze (33)
- Venetian Bronze (47)



4T-141

## 8 SHOWER JET LARGE BRASS SHOWER HEAD | 4T-141

3-1/2" DIAMETER FACE WITH FLOW RESTRICTOR

### 4T-141 FINISHES & PRICE GROUPS:

#### PRICE GROUP A

- Polished Chrome (1)

#### PRICE GROUP B

- Almond (19)

#### PRICE GROUP C

- Polished Brass & PVD (2)
- Antique Brass (3)
- Polished Nickel (30)
- Satin Nickel (31)
- Oil Rubbed Bronze (34)
- Stainless/Brushed Nickel (50)

# 10" ROUND SHOWER HEAD

4T-124



< A THIN 2.5 mm THICK

## 4T-124 FINISH & PRICE GROUP:

### PRICE GROUP A

- Polished Chrome (1) ONLY

## 10" ROUND STAINLESS STEEL SHOWER HEAD | 4T-124

FEATURES 558 NOZZLES

SHOWER HEAD IS 2.5 mm THICK

1.75 GPM

FLOW RESTRICTOR

SHOWN WITH 4T-145 SHEPHERD'S CROOK 16" SHOWER ARM

SHOWER ARM NOT INCLUDED, AVAILABLE ON PAGE 84

# SHEPHERD'S CROOK SHOWER ARM & FLANGE

4T-145

NEW

## 16" BRASS SHEPHERD'S CROOK SHOWER ARM | 4T-145

GREAT FOR USE WITH RAIN SHOWER HEADS

INCLUDES FLANGE (4T-132)



4T-145

FLAT BLACK (20)



POLISHED CHROME (1)

### 4T-145 FINISHES & PRICE GROUP

#### PRICE GROUP A

- Polished Chrome (1)

#### PRICE GROUP B

- Flat Black (20)

#### PRICE GROUP C

- Polished Brass & PVD (2)
- Satin Brass (5)
- Satin Nickel (31)
- Oil Rubbed Bronze (34)
- Stainless/Brushed Nickel (50)

#### PRICE GROUP D

- Light Brushed Bronze (38)



# 8" ROUND SHOWER HEAD

4T-128

NEW

## 8" ROUND STAINLESS STEEL SHOWER HEAD | 4T-128

FEATURE 75 NOZZLES



4T-128

< A THIN 6 mm

### 4T-128

#### FINISHES & PRICE GROUP

##### PRICE GROUP A

- Polished Chrome (1)

##### PRICE GROUP B

- Flat Black (20)

##### PRICE GROUP C

- Polished Brass & PVD (2)
- Satin Nickel (31)
- Oil Rubbed Bronze (34)

##### PRICE GROUP D

- Light Brushed Bronze (38)

SHOWN WITH THE 4T-145 SHEPHERD'S CROOK SHOWER ARM

SHOWER ARM NOT INCLUDED, AVAILABLE ON PAGE 84

# SHOWER ARMS & FLANGES

4T-146, 4T-148 & 4T-150



4T-146

## 6" BRASS SHOWER ARM | 4T-146

INCLUDES FLANGE (4T-132)



4T-148

## 8" BRASS SHOWER ARM | 4T-148

INCLUDES FLANGE (4T-132)



4T-150

## 10" BRASS SHOWER ARM | 4T-150

INCLUDES FLANGE (4T-132)

### 4T-146, 4T-148 & 4T-150 FINISHES & PRICE GROUPS:

#### PRICE GROUP A

- Polished Chrome (1)

#### PRICE GROUP B

- White (13)
- Gloss Black (15)
- Almond (19)
- Flat Black (20)

#### PRICE GROUP C

- Polished Brass & PVD (2)
- Antique Brass (3)
- Antique Nickel (Pewter) (4)

- Satin Brass (5)
- Satin Chrome (6)
- Polished Nickel (30)
- Satin Nickel (31)
- Oil Rubbed Bronze (34)
- Stainless/Brushed Nickel (50)

#### PRICE GROUP D

- Satin Gold (35)
- Antique Copper (36)  
4T-148 only
- Light Brushed Bronze (38)
- Venezian Bronze (47)

# SHOWER ARMS & FLANGES

4T-147, 4T-149 & 4T-151D

## 4T-147 FINISHES & PRICE GROUPS:

### PRICE GROUP A

- Polished Chrome (1)

### PRICE GROUP C

- Polished Brass & PVD (2)
- Polished Nickel (30)
- Satin Nickel (31)
- Oil Rubbed Bronze (34)
- Stainless/Brushed Nickel (50)

## 4T-149 FINISHES & PRICE GROUPS:

### PRICE GROUP A

- Polished Chrome (1)

### PRICE GROUP B

- White (13)
- Flat Black (20)

### PRICE GROUP C

- Polished Brass & PVD (2)
- Antique Nickel (Pewter) (4)
- Polished Nickel (30)
- Satin Nickel (31)
- Oil Rubbed Bronze (34)
- Stainless/Brushed Nickel (50)

### PRICE GROUP D

- Light Brushed Bronze (38)
- Aged Pewter (40)
- Venezian Bronze (47)

## 4T-151D FINISHES & PRICE GROUPS:

### PRICE GROUP A

- Polished Chrome (1)

### PRICE GROUP B

- Flat Black (20)

### PRICE GROUP C

- Polished Brass & PVD (2)
- Antique Brass (3)
- Antique Nickel (Pewter) (4)
- Satin Brass (5)
- Polished Nickel (30)
- Satin Nickel (31)
- Oil Rubbed Bronze (34)
- Stainless/Brushed Nickel (50)

### PRICE GROUP D

- Satin Gold (35)
- Light Brushed Bronze (38)
- Venezian Bronze (47)

## 12" HOOK SHOWER ARM | 4T-147

WELDED FLANGE



## 1/2" X 12" L SHOWER ARM | 4T-149

INCLUDES FLANGE (4T-132)



## "S" SHOWER ARM | 4T-151D

INCLUDES FLANGE (4T-132)

RAISES SHOWER HEAD APPROXIMATELY 10" FROM INLET



# SHOWER ARMS

1/2" IPS | 12", 18" & 24" LENGTH

4T-415N, 4T-416N, & 4T-417N

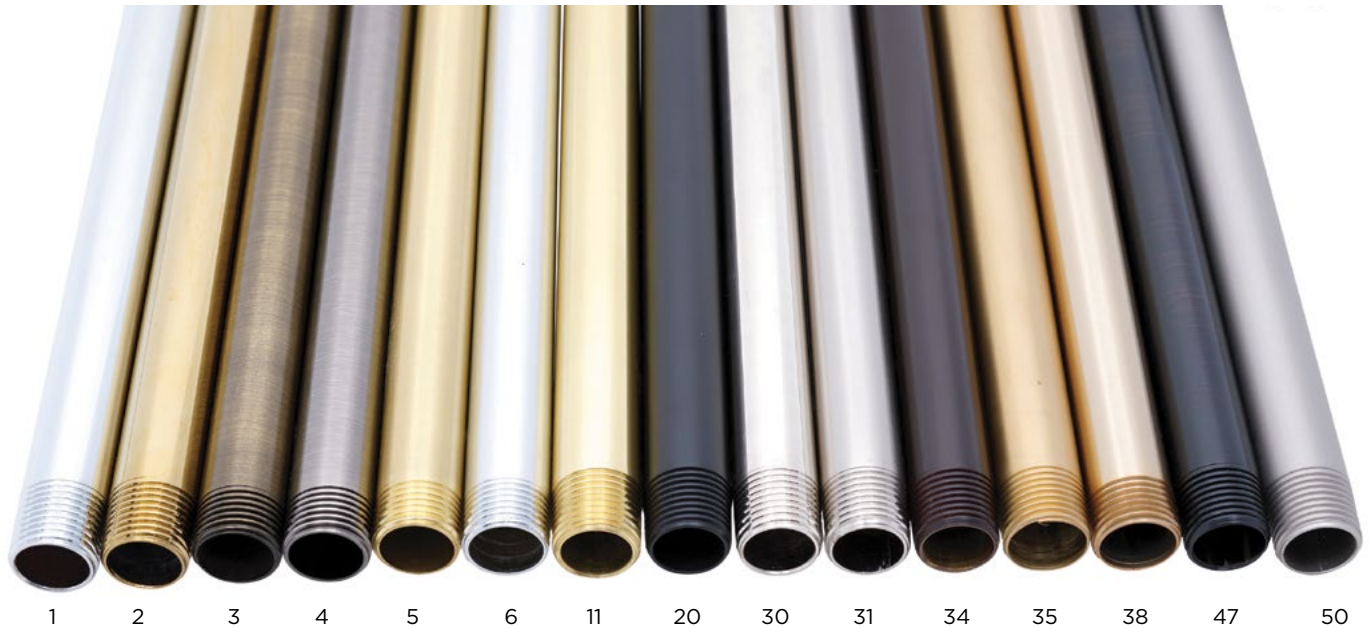

## 1/2" IPS X 12" CEILING MOUNT SHOWER ARM | 4T-415N

12" LENGTH, FLANGE NOT INCLUDED

## 1/2" IPS X 18" CEILING MOUNT SHOWER ARM | 4T-416N

18" LENGTH, FLANGE NOT INCLUDED

## 1/2" IPS X 24" CEILING MOUNT SHOWER ARM | 4T-417N

24" LENGTH, FLANGE NOT INCLUDED

### 4T-415N, 4T-416N, & 4T-417N FINISHES & PRICE GROUPS:

#### PRICE GROUP A

- Polished Chrome (1)

#### PRICE GROUP B

- Flat Black (20)

#### PRICE GROUP C

- Polished Brass & PVD (2)
- Antique Brass (3)
- Antique Nickel (Pewter) (4)
- Satin Brass (5)
- Satin Chrome (6)
- Polished Nickel (30)
- Satin Nickel (31)
- Oil Rubbed Bronze (34)
- Stainless/Brushed Nickel (50)

#### PRICE GROUP D

- Uncoated Polished Brass (11)
- Satin Gold (35)
- Light Brushed Bronze (38)
- Venezian Bronze (47)

# SHOWER ARMS

1/2" IPS | 30" - 60" LENGTH

4T-418N, 4T-419N, 4T-420N, 4T-421N, 4T-422N & 4T-423N

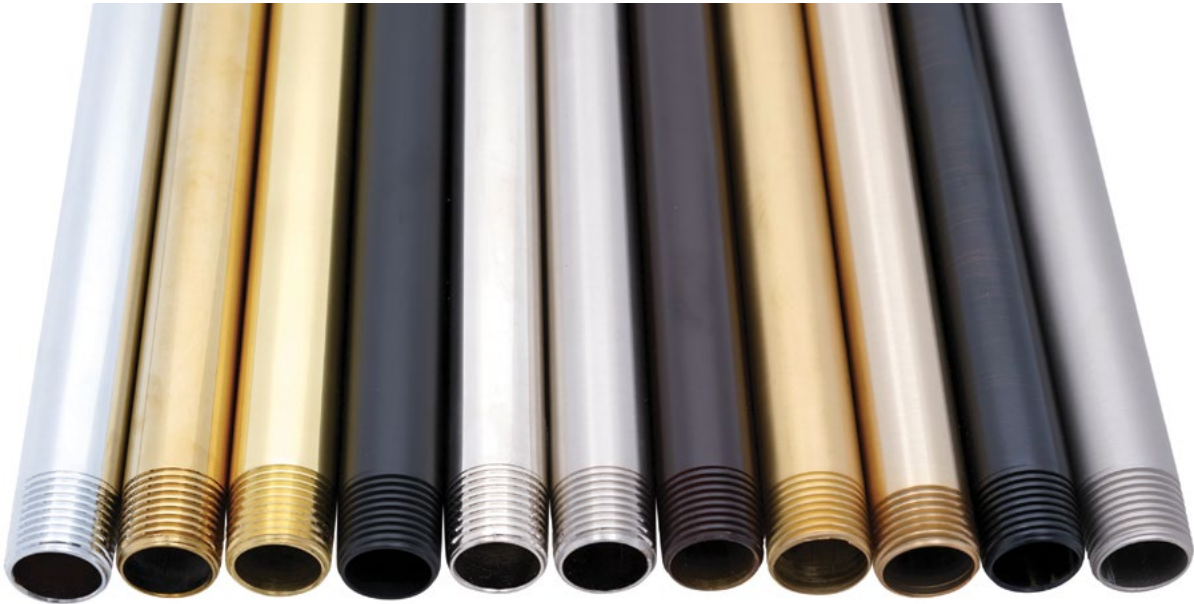

1 2 11 20 30 31 34 35 38 47 50

## 1/2" IPS X 30" CEILING MOUNT SHOWER ARM | 4T-418N

FLANGE NOT INCLUDED

## 1/2" IPS X 36" CEILING MOUNT SHOWER ARM | 4T-419N

FLANGE NOT INCLUDED

## 1/2" IPS X 48" CEILING MOUNT SHOWER ARM | 4T-420N

FLANGE NOT INCLUDED

## 1/2" IPS X 42" CEILING MOUNT SHOWER ARM | 4T-421N

FLANGE NOT INCLUDED

## 1/2" IPS X 54" CEILING MOUNT SHOWER ARM | 4T-422N

FLANGE NOT INCLUDED

## 1/2" IPS X 60" CEILING MOUNT SHOWER ARM | 4T-423N

FLANGE NOT INCLUDED

### 4T-418N, 4T-419N, 4T-420N, 4T-421N, 4T-422N & 4T-423N FINISHES & PRICE GROUPS:

#### PRICE GROUP A

- Polished Chrome (1)

#### PRICE GROUP B

- Flat Black (20)

#### PRICE GROUP C

- Polished Brass & PVD (2)
- Polished Nickel (30)
- Satin Nickel (31)
- Oil Rubbed Bronze (34)
- Stainless/Brushed Nickel (50)

#### PRICE GROUP D

- Uncoated Polished Brass (11)
- Satin Gold (35)
- Light Brushed Bronze (38)
- Venezian Bronze (47)



# SHOWER ARM FLANGES

4T-132 & 4T-152

## SHOWER ARM FLANGE (SURE GRIP STYLE) | 4T-132

2-3/8" OD



4T-132

### 4T-132 FINISHES & PRICE GROUPS:

#### PRICE GROUP A

- Polished Chrome (1)

#### PRICE GROUP B

- White (13)
- Gloss Black (15)
- Biscuit (16)
- Almond (19)
- Flat Black (20)

#### PRICE GROUP C

- Polished Brass & PVD (2)
- Antique Brass (3)
- Antique Nickel (Pewter) (4)
- Satin Brass (5)
- Satin Chrome (6)
- Polished Nickel (30)

- Satin Nickel (31)

- Oil Rubbed Bronze (34)

- Stainless/Brushed Nickel (50)

#### PRICE GROUP D

- Polished Gold (8)

- Uncoated Polished Brass (11)

- Black Nickel (12)

- Antique Bronze (33)

- Satin Gold (35)

- Antique Copper (36)

- Satin Copper (37)

- Light Brushed Bronze (38)

- Aged Pewter (40)

- Antique Gold (46)

- Venezian Bronze (47)

## SHOWER ARM FLANGE WITH SET SCREW | 4T-152

2-3/4" OD



4T-152

### 4T-152 FINISHES & PRICE GROUPS:

#### PRICE GROUP A

- Polished Chrome (1)

#### PRICE GROUP B

- White (13)
- Flat Black (20)

#### PRICE GROUP C

- Polished Brass & PVD (2)
- Antique Brass (3)
- Antique Nickel (Pewter) (4)
- Satin Brass (5)

- Satin Chrome (6)

- Polished Nickel (30)

- Satin Nickel (31)

- Oil Rubbed Bronze (34)

- Stainless/Brushed Nickel (50)

#### PRICE GROUP D

- Black Nickel (12)

- Light Gold (32)

- Antique Copper (36)

- Venezian Bronze (47)

# SHOWER ARM FLANGES & VOLUME CONTROL

4T-153 & 4T-156

## CAST BRASS SHOWER ARM FLANGE W/ SET SCREW | 4T-153

3-1/4" OD



4T-153

### 4T-153 FINISHES & PRICE GROUPS:

#### PRICE GROUP A

- Polished Chrome (1)

#### PRICE GROUP B

- Flat Black (20)

#### PRICE GROUP C

- Polished Brass & PVD (2)
- Antique Nickel (Pewter) (4)
- Polished Nickel (30)

- Satin Nickel (31)

- Oil Rubbed Bronze (34)

- Stainless/Brushed Nickel (50)

#### PRICE GROUP D

- Satin Gold (35)

- Light Brushed Bronze (38)

- Venezian Bronze (47)

## BRASS VOLUME CONTROL | 4T-156

1/2" INLET

1/2" OUTLET WITH "O" RING SEAL



4T-156

### 4T-156 FINISHES & PRICE GROUPS:

#### PRICE GROUP A

- Polished Chrome (1)

#### PRICE GROUP B

- White (13)
- Almond (19)
- Flat Black (20)

#### PRICE GROUP C

- Polished Brass & PVD (2)
- Antique Brass (3)
- Antique Nickel (Pewter) (4)
- Satin Brass (5)

- Satin Chrome (6)

- Polished Nickel (30)

- Satin Nickel (31)

- Oil Rubbed Bronze (34)

- Stainless/Brushed Nickel (50)

#### PRICE GROUP D

- Black Nickel (12)

- Satin Gold (35)

- Light Brushed Bronze (38)

- Venezian Bronze (47)

# TUB SPOUTS

4T-160, 4T-164 & 4T-165



4T-160



4T-164

## 1/2" IPS FRONT CONNECT ZINC DIE CAST TUB SPOUT | 4T-160

5" LENGTH - 2-5/8" BASE

## QUICK CONNECT ZINC DIE CAST TUB SPOUT | 4T-164

5" LENGTH

QUICK-CONNECT SLIDE FOR 1/2" COPPER WIRE TUBE

### 4T-160 & 4T-164

#### FINISHES & PRICE GROUPS:

##### PRICE GROUP A

- Polished Chrome (1)

##### PRICE GROUP B

- White (13)

##### PRICE GROUP C

- Polished Brass & PVD (2)
- Satin Nickel (31)
- Oil Rubbed Bronze (34)
- Stainless/Brushed Nickel (50)



4T-165

## 1/2" IPS FRONT CONNECT BRASS TUB SPOUT | 4T-165

5" LENGTH - 2-1/4" BASE

### 4T-165

#### FINISHES & PRICE GROUPS:

##### PRICE GROUP A

- Polished Chrome (1)

##### PRICE GROUP B

- Gloss Black (15)
- Almond (19)
- Flat Black (20)

##### PRICE GROUP C

- Polished Brass & PVD (2)
- Antique Brass (3)
- Satin Nickel (31)
- Oil Rubbed Bronze (34)
- Stainless/Brushed Nickel (50)

##### PRICE GROUP D

- Satin Gold (35)
- Venetian Bronze (47)

# TUB SPOUTS & REMODEL PLATE

4T-166, 4T-168 & 4T-541

## 4T-166

### FINISHES & PRICE GROUPS:

#### PRICE GROUP A

- Polished Chrome (1)

#### PRICE GROUP C

- Polished Brass & PVD (2)
- Antique Brass (3)
- Satin Nickel (31)
- Oil Rubbed Bronze (34)
- Stainless/Brushed Nickel (50)



4T-166

## 1/2" IPS BACK CONNECT BRASS TUB SPOUT | 4T-166

5" LENGTH - 2-3/16" BASE

## 4T-168

### FINISHES & PRICE GROUPS:

#### PRICE GROUP A

- Polished Chrome (1)

#### PRICE GROUP B

- White (13)

#### PRICE GROUP C

- Polished Brass & PVD (2)
- Satin Nickel (31)
- Oil Rubbed Bronze (34)
- Stainless/Brushed Nickel (50)

#### PRICE GROUP D

- Satin Gold (35)
- Venezian Bronze (47)



4T-168

## 8-1/2" BRASS TUB SPOUT | 4T-168

1/2" TO 3/4" IPS BACK CONNECT

INCLUDES REDUCING BUSHING

## 4T-541

### FINISHES & PRICE GROUPS:

#### PRICE GROUP A

- Polished Chrome (1)

#### PRICE GROUP B

- White (13)
- Biscuit (16)
- Almond (19)
- Flat Black (20)

#### PRICE GROUP C

- Polished Brass & PVD (2)
- Antique Brass (3)
- Polished Nickel (30)
- Satin Nickel (31)
- Oil Rubbed Bronze (34)
- Stainless/Brushed Nickel (50)

#### PRICE GROUP D

- Venezian Bronze (47)



4T-541

## ONE HOLE REMODEL PLATE | 4T-541

FITS MOEN AND DELTA

13" LENGTH, 7 3/8" HEIGHT

HOLE IS 5" DIAMETER

# DIVERTER SPOUTS

4T-162, 4T-163 & 4T-167

4T-162



**1/2" IPS FRONT CONNECT ZINC DIE CAST  
DIVERTER SPOUT | 4T-162**

5" LENGTH - 2-5/8" BASE

**4T-162**

**FINISHES & PRICE GROUPS:**

**PRICE GROUP A**

- Polished Chrome (1)

**PRICE GROUP B**

- White (13)
- Flat Black (20)

**PRICE GROUP C**

- Polished Brass & PVD (2)
- Antique Brass (3)
- Satin Nickel (31)
- Oil Rubbed Bronze (34)
- Stainless/Brushed Nickel (50)

4T-163



**QUICK CONNECT ZINC DIE CAST DIVERTER  
TUB SPOUT | 4T-163**

5" LENGTH - 2-3/8" BASE

**4T-163**

**FINISHES & PRICE GROUPS:**

**PRICE GROUP A**

- Polished Chrome (1)

**PRICE GROUP B**

- White (13)
- Flat Black (20)

**PRICE GROUP C**

- Polished Brass & PVD (2)
- Satin Nickel (31)
- Oil Rubbed Bronze (34)
- Stainless/Brushed Nickel (50)

4T-167



**1/2" - 3/4" IPS BACK CONNECT BRASS  
DIVERTER SPOUT | 4T-167**

5" LENGTH - INCLUDES REDUCING BUSHING

**4T-167**

**FINISHES & PRICE GROUPS:**

**PRICE GROUP A**

- Polished Chrome (1)

**PRICE GROUP B**

- White (13)
- Almond (19)
- Flat Black (20)

**PRICE GROUP C**

- Polished Brass & PVD (2)
- Antique Brass (3)
- Polished Nickel (30)
- Satin Nickel (31)
- Oil Rubbed Bronze (34)
- Stainless/Brushed Nickel (50)

**PRICE GROUP D**

- Polished Gold (8)
- Satin Gold (35)
- Venezian Bronze (47)



# CLOSET SUPPLY SET

4T-715 & 4T-715X

## CLOSET SUPPLY SET | 4T-715

### INCLUDES

- 3/8" IPS X 3/8 OD" COMP ANGLE STOP (4T-38638)
- 3/8" OD X 20" FLATHEAD RIGID SUPPLY TUBE (4T-2739)
- 3/8" X 4" NIPPLE (4T-430N)
- 3/8" IPS SURE GRIP FLANGE (4T- 28438)



## CLOSET SUPPLY SET WITH CROSS HANDLE | 4T-715X

### INCLUDES

- 3/8" IPS X 3/8 OD" COMP CROSS HANDLE ANGLE STOP (4T-38638X)
- 3/8" OD X 20" FLATHEAD RIGID SUPPLY TUBE (4T- 2739)
- 3/8" X 4" NIPPLE (4T-430N)
- 3/8" IPS SURE GRIP FLANGE (4T-28438)



### 4T-715 & 4T-715X

#### FINISHES & PRICE GROUPS:

##### PRICE GROUP A

- Polished Chrome (1)

##### PRICE GROUP B

- White (13)
- Flat Black (20)

##### PRICE GROUP C

- Polished Brass & PVD (2)
- Antique Brass (3)
- Satin Brass (5)
- Satin Chrome (6)
- Polished Nickel (30)
- Satin Nickel (31)
- Oil Rubbed Bronze (34)
- Stainless/Brushed Nickel (50)

##### PRICE GROUP D

- Satin Gold (35)
- Light Brushed Bronze (38)
- Venezian Bronze (47)

# CLOSET SUPPLY SET

4T-716 & 4T-716X



4T-716

## CLOSET SUPPLY SET | 4T-716

INCLUDES

- 1/2" IPS X 1/2" OR 7/16" SJ ANGLE STOP (4T-286)
- 1/2" OD X 20" FLAT HEAD RIGID SUPPLY TUBE (4T-2781D)
- 1/2" X 4" NIPPLE (4T-405N)
- 1/2" IPS SURE GRIP FLANGE (4T-284)



4T-716X

## CLOSET SUPPLY SET WITH CROSS HANDLE | 4T-716X

INCLUDES

- 1/2" IPS X 1/2" OR 7/16" SJ CROSS HANDLE ANGLE STOP (4T-286X)
- 1/2" OD X 20" FLAT HEAD RIGID SUPPLY TUBE (4T-2781D)
- 1/2" X 4" NIPPLE (4T-405N)
- 1/2" IPS SURE GRIP FLANGE (4T-284)

### 4T-716 & 4T-716X FINISHES & PRICE GROUPS:

#### PRICE GROUP A

- Polished Chrome (1)

#### PRICE GROUP B

- White (13)
- Flat Black (20)

#### PRICE GROUP C

- Polished Brass & PVD (2)
- Antique Brass (3)
- Satin Brass (5)
- Polished Nickel (30)
- Satin Nickel (31)
- Oil Rubbed Bronze (34)
- Stainless/Brushed Nickel (50)

#### PRICE GROUP D

- Satin Gold (35)
- Light Brushed Bronze (38)
- Venezian Bronze (47)

# CLOSET SUPPLY SET

4T-717 & 4T-717X

## CLOSET SUPPLY SET | 4T-717

### INCLUDES

- 1/2" COMP X 3/8" OD COMP ANGLE STOP (4T-28738)
- 3/8" OD X 20" FLAT HEAD RIGID SUPPLY TUBE (4T-2739)
- 5/8" OD SURE GRIP FLANGE (4T-285)



## 4T-717 & 4T-717X

### FINISHES & PRICE GROUPS:

#### PRICE GROUP A

- Polished Chrome (1)

#### PRICE GROUP B

- White (13)
- Biscuit (16)
- Flat Black (20)

#### PRICE GROUP C

- Polished Brass & PVD (2)
- Antique Brass (3)
- Antique Nickel (Pewter) (4)
- Satin Brass (5)
- Satin Chrome (6)
- Polished Nickel (30)
- Satin Nickel (31)
- Oil Rubbed Bronze (34)
- Stainless/Brushed Nickel (50)

#### PRICE GROUP D

- Light Gold (32)
- Antique Bronze (33)
- Satin Gold (35)
- Antique Copper (36)
- Satin Copper (37)
- Light Brushed Bronze (38)
- Venezian Bronze (47)



## CLOSET SUPPLY SET WITH CROSS HANDLE | 4T-717X

### INCLUDES

- 1/2" COMP X 3/8" OD COMP CROSS HANDLE ANGLE STOP (4T-28738X)
- 3/8" OD X 20" FLAT HEAD RIGID SUPPLY TUBE (4T-2739)
- 5/8" OD SURE GRIP FLANGE (4T-285)

# CLOSET SUPPLY SET

4T-718 & 4T-718X



4T-718

## CLOSET SUPPLY SET | 4T-718

### INCLUDES

- 1/2" COMP X 1/2" OR 7/16" SJ ANGLE STOP (4T-287)
- 1/2" OD X 20" FLAT HEAD RIGID SUPPLY TUBE (4T-2781D)
- 5/8" OD SURE GRIP FLANGE (4T-285)



4T-718X

## CLOSET SUPPLY SET WITH CROSS HANDLE | 4T-718X

### INCLUDES

- 1/2" COMP X 1/2" OR 7/16" SJ CROSS HANDLE ANGLE STOP (4T-287X)
- 1/2" OD X 20" FLAT HEAD RIGID SUPPLY TUBE (4T-2781D)
- 5/8" OD SURE GRIP FLANGE (4T-285)

### 4T-718 & 4T-718X FINISHES & PRICE GROUPS:

#### PRICE GROUP A

- Polished Chrome (1)

#### PRICE GROUP B

- White (13)
- Flat Black (20)

#### PRICE GROUP C

- Polished Brass & PVD (2)
- Antique Brass (3)
- Satin Brass (5)
- Polished Nickel (30)
- Satin Nickel (31)
- Oil Rubbed Bronze (34)
- Stainless/Brushed Nickel (50)

#### PRICE GROUP D

- Venezian Bronze (47)

# LAVATORY SUPPLY SETS

4T-725, 4T-725X, 4T-726 & 4T-726X

## LAVATORY SUPPLY SET | 4T-725

INCLUDES

- (2) 3/8" IPS X 3/8 OD" COMP ANGLE STOPS (4T-38638)
- (2) 3/8" OD X 20" BULLNOSE RIGID SUPPLY TUBES (4T-2838)
- (2) 3/8" X 4" NIPPLES (4T-430N)
- (2) 3/8" IPS SURE GRIP FLANGES (4T-28438)



### 4T-725 & 4T-725X

#### FINISHES & PRICE GROUPS:

##### PRICE GROUP A

- Polished Chrome (1)

##### PRICE GROUP B

- White (13)
- Flat Black (20)

##### PRICE GROUP C

- Polished Brass & PVD (2)
- Antique Brass (3)
- Satin Brass (5)
- Satin Chrome (6)
- Polished Nickel (30)
- Satin Nickel (31)
- Oil Rubbed Bronze (34)
- Stainless/Brushed Nickel (50)

##### PRICE GROUP D

- Satin Gold (35)
- Light Brushed Bronze (38)
- Venezian Bronze (47)

## LAVATORY SUPPLY SET WITH CROSS HANDLE | 4T-725X

INCLUDES

- (2) 3/8" IPS X 3/8 OD" COMP CROSS HANDLE ANGLE STOPS (4T-38638X)
- (2) 3/8" OD X 20" BULLNOSE RIGID SUPPLY TUBES (4T-2838)
- (2) 3/8" X 4" NIPPLES (4T-430N)
- (2) 3/8" IPS SURE GRIP FLANGES (4T-28438)



### 4T-726 & 4T-726X

#### FINISHES & PRICE GROUPS:

##### PRICE GROUP A

- Polished Chrome (1)

##### PRICE GROUP B

- White (13)
- Flat Black (20)

##### PRICE GROUP C

- Polished Brass & PVD (2)
- Antique Brass (3)
- Satin Brass (5)
- Polished Nickel (30)
- Satin Nickel (31)
- Oil Rubbed Bronze (34)
- Stainless/Brushed Nickel (50)

##### PRICE GROUP D

- Satin Gold (35)
- Light Brushed Bronze (38)
- Venezian Bronze (47)

## LAVATORY SUPPLY SET | 4T-726

INCLUDES

- (2) 1/2" IPS X 3/8 OD" COMP ANGLE STOPS (4T-28638)
- (2) 3/8" OD X 20" BULLNOSE RIGID SUPPLY TUBES (4T-2838)
- (2) 1/2" X 4" NIPPLES (4T-405N)
- (2) 1/2" IPS SURE GRIP FLANGES (4T-284)

## LAVATORY SUPPLY SET WITH CROSS HANDLE | 4T-726X

INCLUDES

- (2) 1/2" IPS X 3/8 OD" COMP CROSS HANDLE ANGLE STOPS (4T-28638X)
- (2) 3/8" OD X 20" BULLNOSE RIGID SUPPLY TUBES (4T-2838)
- (2) 1/2" X 4" NIPPLES (4T-405N)
- (2) 1/2" IPS SURE GRIP FLANGES (4T-284)

4T-28638X





# LAVATORY SUPPLY SET

4T-727 & 4T-727X



4T-727

## LAVATORY SUPPLY SET | 4T-727

INCLUDES

- (2) 1/2" IPS X 1/2" OR 7/16" SJ ANGLE STOPS (4T-286)
- (2) 1/2" OD X 20" BULLNOSE RIGID SUPPLY TUBES (4T-2800)
- (2) 1/2" X 4" NIPPLES (4T-405N)
- (2) 1/2" IPS SURE GRIP FLANGES (4T-284)



4T-727X

## LAVATORY CROSS HANDLE SUPPLY SET | 4T-727X

INCLUDES

- (2) 1/2" IPS X 1/2" OR 7/16" SJ CROSS HANDLE ANGLE STOPS (4T-286X)
- (2) 1/2" OD X 20" BULLNOSE RIGID SUPPLY TUBES (4T-2800)
- (2) 1/2" X 4" NIPPLES (4T-405N)
- (2) 1/2" IPS SURE GRIP FLANGES (4T-284)

### 4T-727 & 4T-727X

#### FINISHES & PRICE GROUPS:

##### PRICE GROUP A

- Polished Chrome (1)

##### PRICE GROUP B

- White (13)
- Flat Black (20)

##### PRICE GROUP C

- Polished Brass & PVD (2)
- Antique Brass (3)
- Satin Brass (5)
- Polished Nickel (30)
- Satin Nickel (31)
- Oil Rubbed Bronze (34)
- Stainless/Brushed Nickel (50)

##### PRICE GROUP D

- Satin Gold (35)
- Light Brushed Bronze (38)
- Venetian Bronze (47)

# LAVATORY SUPPLY SET

4T-728 & 4T-728X

## LAVATORY SUPPLY SET | 4T-728

### INCLUDES

- (2) 1/2" COMP X 3/8" OD COMP ANGLE STOPS (4T-28738)
- (2) 3/8" OD X 20" BULLNOSE RIGID SUPPLY TUBES (4T-2838)
- (2) 5/8" OD SURE GRIP FLANGES (4T-285)



### 4T-728 & 4T-728X

#### FINISHES & PRICE GROUPS:

##### PRICE GROUP A

- Polished Chrome (1)

##### PRICE GROUP B

- White (13)
- Biscuit (16)
- Flat Black (20)

##### PRICE GROUP C

- Polished Brass & PVD (2)
- Antique Brass (3)
- Antique Nickel (Pewter) (4)
- Satin Brass (5)
- Satin Chrome (6)
- Polished Nickel (30)
- Satin Nickel (31)
- Oil Rubbed Bronze (34)
- Stainless/Brushed Nickel (50)

##### PRICE GROUP D

- Light Gold (32)
- Antique Bronze (33)
- Satin Gold (35)
- Satin Copper (37)
- Light Brushed Bronze (38)
- Venezian Bronze (47)



## LAVATORY SUPPLY SET WITH CROSS HANDLE | 4T-728X

### INCLUDES

- (2) 1/2" COMP X 3/8" OD COMP CROSS HANDLE ANGLE STOPS (4T-28738X)
- (2) 3/8" OD X 20" BULLNOSE RIGID SUPPLY TUBES (4T-2838)
- (2) 5/8" OD SURE GRIP FLANGES (4T-285)

# FLAT HEAD RIGID SUPPLY TUBES

FOR TOILET APPLICATIONS [4T-2738](#), [4T-2739](#), [4T-2780](#) & [4T-2781D](#)

[4T-2738](#)



**3/8" OD X 12" FLAT HEAD RIGID SUPPLY TUBE | [4T-2738](#)**

SOLD EACH

[4T-2739](#)



**3/8" OD X 20" FLAT HEAD RIGID SUPPLY TUBE | [4T-2739](#)**

SOLD EACH

**1/2" OD X 12" FLAT HEAD RIGID  
SUPPLY TUBE | [4T-2780](#)**

SOLD EACH

[4T-2780](#)



**1/2" OD X 20" FLAT HEAD RIGID  
SUPPLY TUBE | [4T-2781D](#)**

SOLD EACH

[4T-2781D](#)



[4T-2738](#), [4T-2739](#),  
[4T-2780](#) & [4T-2781D](#)

## FINISHES & PRICE GROUPS:

### PRICE GROUP A

- Polished Chrome (1)

### PRICE GROUP B

- White (13)
- Biscuit (16)
- Flat Black (20)

### PRICE GROUP C

- Polished Brass & PVD (2)
- Antique Brass (3)
- Antique Nickel (Pewter) (4)
- Satin Brass (5)
- Satin Chrome (6)
- Polished Nickel (30)
- Satin Nickel (31)
- Oil Rubbed Bronze (34)
- Stainless/Brushed Nickel (50)

### PRICE GROUP D

- Light Gold (32)
- Antique Bronze (33)
- Satin Gold (35)
- Antique Copper (36)
- Light Brushed Bronze (38)
- Venezian Bronze (47)

# 1/2" BULLNOSE RIGID SUPPLY TUBES

FOR LAVATORY APPLICATIONS [4T-2799](#), [4T-2800](#) & [4T-2839](#)

## 1/2" OD X 12" BULLNOSE RIGID SUPPLY TUBE | [4T-2799](#)

SOLD EACH



## 1/2" OD X 20" BULLNOSE RIGID SUPPLY TUBE | [4T-2800](#)

SOLD EACH



## 1/2" OD X 30" BULLNOSE RIGID SUPPLY TUBE | [4T-2839](#)

SOLD EACH



### [4T-2799](#), [4T-2800](#) & [4T-2839](#)

#### FINISHES & PRICE GROUPS:

##### PRICE GROUP A

- Polished Chrome (1)

##### PRICE GROUP B

- White (13)
- Flat Black (20)

##### PRICE GROUP C

- Polished Brass & PVD (2)
- Antique Brass (3)
- Antique Nickel (Pewter) (4)
- Satin Brass (5)

- Satin Chrome (6)
- Polished Nickel (30)
- Satin Nickel (31)
- Oil Rubbed Bronze (34)
- Stainless/Brushed Nickel (50)

##### PRICE GROUP D

- Polished Gold (8)
- Satin Gold (35)
- Light Brushed Bronze (38)
- Venezian Bronze (47)

# 3/8" BULLNOSE RIGID SUPPLY TUBES

4T-28328, 4T-2838 & 4T-2840



**3/8" OD X 12" BULLNOSE RIGID SUPPLY TUBE | 4T-28328**

SOLD EACH

4T-28328



4T-2838

**3/8" OD X 20" BULLNOSE RIGID SUPPLY TUBE | 4T-2838**

SOLD EACH



4T-2840

**3/8" OD X 30" BULLNOSE RIGID SUPPLY TUBE | 4T-2840**

SOLD EACH



## 4T-28328, 4T-2838 & 4T-2840 FINISHES & PRICE GROUPS:

### PRICE GROUP A

- Polished Chrome (1)

### PRICE GROUP B

- White (13)
- Biscuit (16)
- Flat Black (20)

### PRICE GROUP C

- Polished Brass & PVD (2)
- Antique Brass (3)
- Antique Nickel (Pewter) (4)
- Satin Brass (5)
- Satin Chrome (6)
- Polished Nickel (30)

- Satin Nickel (31)
- Oil Rubbed Bronze (34)
- Stainless/Brushed Nickel (50)

### PRICE GROUP D

- Polished Gold (8)
- Light Gold (32)
- Antique Bronze (33)
- Satin Gold (35)
- Antique Copper (36)
- Light Brushed Bronze (38)
- Aged Pewter (40)
- Venezian Bronze (47)



# 1/2" IPS ANGLE STOPS

4T-286, 4T-286X, 4T-28638 & 4T-28638X

## OVAL HANDLE SLIP JOINT ANGLE STOP | 4T-286

1/2" IPS X 1/2" OR 7/16" SLIP JOINT

USE WITH 1/2" OD RISER



4T-286

## CROSS HANDLE ANGLE STOP | 4T-286X

1/2" IPS X 1/2" OR 7/16" SLIP JOINT

USE WITH 1/2" OD RISER



4T-286X

## OVAL HANDLE ANGLE STOP | 4T-28638

1/2" IPS X 3/8" OD COMPRESSION

USE WITH 3/8" OD RISER



4T-28638

### 4T-286, 4T-286X, 4T-28638 & 4T-28638X

#### FINISHES & PRICE GROUPS:

##### PRICE GROUP A

- Polished Chrome (1)

##### PRICE GROUP B

- White (13)
- Flat Black (20)

##### PRICE GROUP C

- Polished Brass & PVD (2)
- Antique Brass (3)
- Satin Brass (5)
- Polished Nickel (30)
- Satin Nickel (31)
- Oil Rubbed Bronze (34)
- Stainless/Brushed Nickel (50)

##### PRICE GROUP D

- Satin Gold (35)
- Light Brushed Bronze (38)
- Venezian Bronze (47)

## CROSS HANDLE ANGLE STOP | 4T-28638X

1/2" IPS X 3/8" OD COMPRESSION

USE WITH 3/8" OD RISER



4T-28638X

# 1/2" IPS ANGLE STOPS

4T-39612 & 4T-39612X

## OVAL HANDLE ANGLE STOP | 4T-39612

1/2" IPS X 1/2" OD COMPRESSION

USE WITH 1/2" OD RISER



4T-39612



4T-39612X

## CROSS HANDLE ANGLE STOP | 4T-39612X

1/2" IPS X 1/2" OD COMPRESSION

USE WITH 1/2" OD RISER

### 4T-39612 & 4T-39612X FINISHES & PRICE GROUPS:

#### PRICE GROUP A

- Polished Chrome (1)

#### PRICE GROUP C

- Polished Brass & PVD (2)
- Polished Nickel (30)
- Satin Nickel (31)
- Oil Rubbed Bronze (34)
- Stainless/Brushed Nickel (50)



# 1/2" NOMINAL COMPRESSION ANGLE STOPS

4T-287, 4T-287X, 4T-39312 & 4T-39312X

## OVAL HANDLE SLIP JOINT ANGLE STOP | 4T-287

1/2" NOMINAL COMPRESSION X 1/2" OD OR 7/16" SJ

USE WITH 1/2" OD RISER

### 4T-287 & 4T-287X

#### FINISHES & PRICE GROUPS:

##### PRICE GROUP A

- Polished Chrome (1)

##### PRICE GROUP B

- White (13)
- Flat Black (20)

##### PRICE GROUP C

- Polished Brass & PVD (2)
- Antique Brass (3)
- Satin Brass (5)
- Polished Nickel (30)
- Satin Nickel (31)
- Oil Rubbed Bronze (34)
- Stainless/Brushed Nickel (50)

##### PRICE GROUP D

- Venezian Bronze (47)



4T-287



4T-287X

## CROSS HANDLE SLIP JOINT ANGLE STOP | 4T-287X

1/2" NOMINAL COMPRESSION X 1/2" OD OR 7/16" SJ

USE WITH 1/2" OD RISER

## OVAL HANDLE ANGLE STOP | 4T-39312

1/2" NOMINAL COMPRESSION X 1/2" OD COMPRESSION

USE WITH 1/2" OD RISER



4T-39312



4T-39312X

### 4T-39312 & 4T-39312X

#### FINISHES & PRICE GROUPS:

##### PRICE GROUP A

- Polished Chrome (1)

##### PRICE GROUP C

- Polished Brass & PVD (2)
- Antique Nickel (Pewter) (4)
- Satin Brass (5)
- Satin Nickel (31)
- Oil Rubbed Bronze (34)
- Stainless/Brushed Nickel (50)

##### PRICE GROUP D

- Satin Gold (35)

## CROSS HANDLE ANGLE STOP | 4T-39312X

1/2" NOMINAL COMPRESSION X 1/2" OD COMPRESSION

USE WITH 1/2" OD RISER

# 1/2" NOMINAL COMPRESSION ANGLE STOPS

4T-28738 & 4T-28738X



## OVAL HANDLE ANGLE STOP | 4T-28738

1/2" NOMINAL COMPRESSION X 3/8" OD COMPRESSION

USE WITH 3/8" OD RISER

4T-28738



4T-28738X

## CROSS HANDLE ANGLE STOP | 4T-28738X

1/2" NOMINAL COMPRESSION X 3/8" OD COMPRESSION

USE WITH 3/8" OD RISER

### 4T-28738 & 4T-28738X FINISHES & PRICE GROUPS:

#### PRICE GROUP A

- Polished Chrome (1)

#### PRICE GROUP B

- White (13)
- Biscuit (16)
- Flat Black (20)

#### PRICE GROUP C

- Polished Brass & PVD (2)
- Antique Brass (3)
- Antique Nickel (Pewter) (4)
- Satin Brass (5)
- Satin Chrome (6)
- Polished Nickel (30)
- Satin Nickel (31)
- Oil Rubbed Bronze (34)
- Stainless/Brushed Nickel (50)

#### PRICE GROUP D

- Uncoated Polished Brass (11)
- Light Gold (32)
- Antique Bronze (33)
- Satin Gold (35)
- Antique Copper (36)
- Satin Copper (37)
- Light Brushed Bronze (38)
- Venezian Bronze (47)

# 1/2" NOMINAL COMPRESSION ANGLE STOPS-QUARTER TURN

4T-55138

## QUARTER TURN 1/2" NOMINAL COMPRESSION X 3/8" OD COMPRESSION ANGLE STOP | 4T-55138

THE QUARTER TURN VERSION OF OUR POPULAR 4T-28738 ANGLE STOP



4T-55138



### 4T-55138

#### FINISHES & PRICE GROUPS:

##### PRICE GROUP A

- Polished Chrome (1)

##### PRICE GROUP B

- Flat Black (20)

##### PRICE GROUP C

- Polished Brass & PVD (2)
- Antique Brass (3)
- Satin Brass (5)
- Polished Nickel (30)
- Satin Nickel (31)
- Oil Rubbed Bronze (34)
- Stainless/Brushed Nickel (50)

##### PRICE GROUP D

- Uncoated Polished Brass (11)
- Satin Gold (35)
- Light Brushed Bronze (38)
- Venezian Bronze (47)



# 1/2" IPS STRAIGHT STOPS

4T-288, 4T-288X, 4T-28838 & 4T-28838X



4T-288

## OVAL HANDLE SLIP JOINT STRAIGHT STOP | 4T-288

1/2" IPS X 1/2" OR 7/16" SJ

USE WITH 1/2" OD RISER INLET IS 1/2" IPS

OUTLET IS 1/2" OD



4T-288X

## CROSS HANDLE SLIP JOINT STRAIGHT STOP | 4T-288X

1/2" IPS X 1/2" OR 7/16" SJ

USE WITH 1/2" OD RISER INLET IS 1/2" IPS

OUTLET IS 1/2" OD



4T-28838

## OVAL HANDLE STRAIGHT STOP | 4T-28838

1/2" IPS X 3/8" OD COMPRESSION

USE WITH 3/8" OD RISER



4T-28838X

## CROSS HANDLE STRAIGHT STOP | 4T-28838X

1/2" IPS X 3/8" OD COMPRESSION

USE WITH 3/8" OD RISER

### 4T-288, 4T-288X, 4T-28838 & 4T-28838X FINISHES & PRICE GROUPS:

#### PRICE GROUP A

- Polished Chrome (1)

#### PRICE GROUP B

- Satin Chrome (6)  
(4T-28838 only)
- Flat Black (20)

#### PRICE GROUP C

- Polished Brass & PVD (2)
- Antique Brass (3)
- Satin Chrome (6)
- Polished Nickel (30)
- Satin Nickel (31)
- Oil Rubbed Bronze (34)
- Stainless/Brushed Nickel (50)

#### PRICE GROUP D

- Antique Brass (3)  
4T-28838 only
- Satin Gold (35)
- Venezian Bronze (47)

# 1/2" IPS STRAIGHT STOPS

4T-39812 & 4T-39812X

## OVAL HANDLE STRAIGHT STOP | 4T-39812

1/2" IPS X 1/2" OD COMPRESSION

USE WITH 1/2" OD RISER



4T-39812



4T-39812X

### 4T-39812 & 4T-39812X

#### FINISHES & PRICE GROUPS:

##### PRICE GROUP A

- Polished Chrome (1)

##### PRICE GROUP B

- Flat Black (20)

##### PRICE GROUP C

- Polished Brass & PVD (2)
- Polished Nickel (30)
- Satin Nickel (31)
- Oil Rubbed Bronze (34)
- Stainless/Brushed Nickel (50)

##### PRICE GROUP D

- Satin Gold (35)

## CROSS HANDLE STRAIGHT STOP | 4T-39812X



# 1/2" NOMINAL COMPRESSION STRAIGHT STOPS

4T-289, 4T-289X, 4T-39412 & 4T-39412X



4T-289

## OVAL HANDLE STRAIGHT STOP | 4T-289

1/2" NOMINAL COMPRESSION X 1/2" OR 7/16" SLIP JOINT

USE WITH 1/2" OD RISER



4T-289X

## CROSS HANDLE STRAIGHT STOP 4T-289X

1/2" NOMINAL COMPRESSION X 1/2" OR 7/16"

SLIP JOINT USE WITH 1/2" OD RISER



4T-39412

## OVAL HANDLE STRAIGHT STOP | 4T-39412

1/2" NOMINAL COMPRESSION X 1/2" OD COMPRESSION

USE WITH 1/2" OD RISER



4T-39412X

## CROSS HANDLE STRAIGHT STOP | 4T-39412X

1/2" NOMINAL COMPRESSION X 1/2" OD COMPRESSION

USE WITH 1/2" OD RISER

### 4T-289 & 4T-289X

#### FINISHES & PRICE GROUPS:

##### PRICE GROUP A

- Polished Chrome (1)

##### PRICE GROUP B

- Flat Black (20)

##### PRICE GROUP C

- Polished Brass & PVD (2)
- Polished Nickel (30)
- Satin Nickel (31)
- Oil Rubbed Bronze (34)
- Stainless/Brushed Nickel (50)

##### PRICE GROUP D

- Satin Gold (35)

### 4T-39412 & 4T-39412X

#### FINISHES & PRICE GROUPS:

##### PRICE GROUP A

- Polished Chrome (1)

##### PRICE GROUP B

- Flat Black (20)

##### PRICE GROUP C

- Polished Brass & PVD (2)
- Antique Brass (3)
- Satin Brass (5)
- Polished Nickel (30)
- Satin Nickel (31)
- Oil Rubbed Bronze (34)
- Stainless/Brushed Nickel (50)

##### PRICE GROUP D

- Satin Gold (35)
- Light Brushed Bronze (38)
- Venezian Bronze (47)

# 1/2" NOMINAL COMPRESSION STRAIGHT STOPS

4T-28938 & 4T-28938X

## OVAL HANDLE STRAIGHT STOP | 4T-28938

1/2" NOMINAL COMPRESSION X 3/8" OD COMPRESSION

USE WITH 3/8" OD RISER



4T-28938



4T-28938X

### 4T-28938 & 4T-28938X FINISHES & PRICE GROUPS:

#### PRICE GROUP A

- Polished Chrome (1)

#### PRICE GROUP B

- White (13)
- Flat Black (20)

#### PRICE GROUP C

- Polished Brass & PVD (2)
- Antique Brass (3)
- Antique Nickel (Pewter) (4)
- Satin Brass (5)
- Satin Chrome (6)
- Polished Nickel (30)
- Satin Nickel (31)
- Oil Rubbed Bronze (34)
- Stainless/Brushed Nickel (50)

#### PRICE GROUP D

- Satin Gold (35)
- Light Brushed Bronze (38)
- Venezian Bronze (47)

## CROSS HANDLE STRAIGHT STOP | 4T-28938X

1/2" NOMINAL COMPRESSION X 3/8" OD COMPRESSION

USE WITH 3/8" OD RISER

# 3/8" IPS ANGLE STOPS

4T-38638 & 4T-38638X



## OVAL HANDLE ANGLE STOP | 4T-38638

3/8" IPS X 3/8" OD COMPRESSION

USE WITH 3/8" OD RISER

4T-38638



4T-38638X

## CROSS HANDLE ANGLE STOP | 4T-38638X

3/8" IPS X 3/8" OD COMPRESSION

USE WITH 3/8" OD RISER

### 4T-38638 & 4T-38638X FINISHES & PRICE GROUPS:

#### PRICE GROUP A

- Polished Chrome (1)

#### PRICE GROUP B

- White (13)
- Flat Black (20)

#### PRICE GROUP C

- Polished Brass & PVD (2)
- Antique Brass (3)
- Satin Brass (5)
- Satin Chrome (6)
- Polished Nickel (30)
- Satin Nickel (31)
- Oil Rubbed Bronze (34)
- Stainless/Brushed Nickel (50)

#### PRICE GROUP D

- Satin Gold (35)
- Light Brushed Bronze (38)
- Venezian Bronze (47)





# 3/8" IPS STRAIGHT STOPS

4T-38838 & 4T-38838X

## OVAL HANDLE STRAIGHT STOP | 4T-38838

3/8" IPS X 3/8" OD COMPRESSION

USE WITH 3/8" OD RISER



4T-38838



4T-38838X

### 4T-38838 & 4T-38838X

#### FINISHES & PRICE GROUPS:

##### PRICE GROUP A

- Polished Chrome (1)

##### PRICE GROUP B

- Flat Black (20)

##### PRICE GROUP C

- Polished Brass & PVD (2)
- Antique Brass (3)
- Satin Brass (5)
- Polished Nickel (30)
- Satin Nickel (31)
- Oil Rubbed Bronze (34)
- Stainless/Brushed Nickel (50)

##### PRICE GROUP D

- Satin Gold (35)
- Light Brushed Bronze (38)
- Venezian Bronze (47)

## CROSS HANDLE STRAIGHT STOP | 4T-38838X

3/8" IPS X 3/8" OD COMPRESSION

USE WITH 3/8" OD RISER



# STOPS WITH 5" EXTENSION TUBES

4T-29212, 4T-29212X, 4T-29412 & 4T-29412X



4T-29212

## OVAL HANDLE ANGLE STOP W/ 5" EXTENSION TUBE | 4T-29212

1/2" NOMINAL SWEAT X 1/2" OD COMPRESSION

INCLUDES BELL FLANGE (4T-307)



4T-29212X

## CROSS HANDLE ANGLE STOP W/ 5" EXTENSION TUBE | 4T-29212X

1/2" NOMINAL SWEAT X 1/2" OD COMPRESSION

INCLUDES BELL FLANGE (4T-307)



4T-29412

## OVAL HANDLE STRAIGHT STOP W/ 5" EXTENSION TUBE | 4T-29412

1/2" NOMINAL SWEAT X 1/2" OD COMPRESSION

INCLUDES BELL FLANGE (4T-307)



4T-29412X

## CROSS HANDLE STRAIGHT STOP W/ 5" EXTENSION TUBE | 4T-29412X

1/2" NOMINAL SWEAT X 1/2" OD COMPRESSION

INCLUDES BELL FLANGE (4T-307)

### 4T-29212, 4T-29212X, 4T-29412 & 4T-29412X FINISHES & PRICE GROUPS:

#### PRICE GROUP A

- Polished Chrome (1)

#### PRICE GROUP B

- Flat Black (20)

#### PRICE GROUP C

- Polished Brass & PVD (2)
- Antique Brass (3)
- Satin Brass (5)
- Polished Nickel (30)
- Satin Nickel (31)
- Oil Rubbed Bronze (34)
- Stainless/Brushed Nickel (50)

#### PRICE GROUP D

- Satin Gold (35)  
4T-29212 & 4T-29212X only
- Light Brushed Bronze (38)  
4T-29212 & 4T-29212X only

# STOPS WITH 5" EXTENSION TUBES

4T-29238, 4T-29238X, 4T-29438, & 4T-29438X

## OVAL HANDLE ANGLE STOP W/ 5" EXTENSION TUBE | 4T-29238

1/2" NOMINAL SWEAT X 3/8" OD COMPRESSION

INCLUDES BELL FLANGE (4T-307)



## CROSS HANDLE ANGLE STOP W/ 5" EXTENSION TUBE | 4T-29238X

1/2" NOMINAL SWEAT X 3/8" OD COMPRESSION

INCLUDES BELL FLANGE (4T-307)



## OVAL HANDLE STRAIGHT STOP W/ 5" EXTENSION TUBE | 4T-29438

1/2" NOMINAL SWEAT X 3/8" OD COMPRESSION

INCLUDES BELL FLANGE (4T-307)



## CROSS HANDLE STRAIGHT STOP W/ 5" EXTENSION TUBE | 4T-29438X

1/2" NOMINAL SWEAT X 3/8" OD COMPRESSION

INCLUDES BELL FLANGE (4T-307)

### 4T-29238, 4T-29238X, 4T-29438, & 4T-29438X FINISHES & PRICE GROUPS:

#### PRICE GROUP A

- Polished Chrome (1)

#### PRICE GROUP B

- Flat Black (20)

#### PRICE GROUP C

- Polished Brass & PVD (2)
- Antique Brass (3)
- Satin Brass (5)
- Polished Nickel (30)
- Satin Nickel (31)
- Oil Rubbed Bronze (34)
- Stainless/Brushed Nickel (50)

#### PRICE GROUP D

- Satin Gold (35)
- Light Brushed Bronze (38)
- Venezian Bronze (47)

# STOPS WITH CORRUGATED RISERS

4T-3812, 4T-3812X, 4T-3815, 4T-3815X, 4T-3820 & 4T-3820X



4T-3812

## OVAL HANDLE ANGLE STOP W/ CORRUGATED RISER | 4T-3812

3/8" OD X 12" FLEX RISER AND 1/2" COMPRESSION ANGLE STOP

INCLUDES 5/8" OD SURE GRIP FLANGE (4T-285)



4T-3812X

## CROSS HANDLE ANGLE STOP W/ CORRUGATED RISER | 4T-3812X

3/8" OD X 12" FLEX RISER AND 1/2" COMPRESSION ANGLE STOP

INCLUDES 5/8" OD SURE GRIP FLANGE (4T-285)



4T-3815

## OVAL HANDLE ANGLE STOP W/ CORRUGATED RISER | 4T-3815

3/8" OD X 15" FLEX RISER AND  
1/2" COMPRESSION ANGLE STOP

INCLUDES 5/8" OD SURE GRIP FLANGE (4T-285)



4T-3815X

## CROSS HANDLE ANGLE STOP W/ CORRUGATED RISER | 4T-3815X

3/8" OD X 15" FLEX RISER AND  
1/2" COMPRESSION ANGLE STOP

INCLUDES 5/8" OD SURE GRIP FLANGE (4T-285)



4T-3820

## OVAL HANDLE ANGLE STOP W/ CORRUGATED RISER | 4T-3820

3/8" OD X 20" FLEX RISER AND 1/2"  
COMPRESSION ANGLE STOP

INCLUDES 5/8" OD SURE GRIP FLANGE (4T-285)



4T-3820X

## CROSS HANDLE ANGLE STOP W/ CORRUGATED RISER | 4T-3820X

3/8" OD X 20" FLEX RISER AND 1/2"  
COMPRESSION ANGLE STOP

INCLUDE 5/8" OD SURE GRIP FLANGE (4T-285)

### 4T-3812, 4T-3812X, 4T-3815 & 4T-3815X FINISHES & PRICE GROUPS:

#### PRICE GROUP A

- Polished Chrome (1)

#### PRICE GROUP B

- Flat Black (20)

#### PRICE GROUP C

- Polished Brass & PVD (2)
- Antique Brass (3)
- Antique Nickel (Pewter) (4)
- Satin Chrome (6)
- Satin Nickel (31)
- Oil Rubbed Bronze (34)
- Stainless/Brushed Nickel (50)

### 4T-3820 & 4T-3820X FINISHES & PRICE GROUPS:

#### PRICE GROUP A

- Polished Chrome (1)

#### PRICE GROUP B

- Flat Black (20)

#### PRICE GROUP C

- Polished Brass & PVD (2)
- Antique Nickel (Pewter) (4)
- Satin Nickel (31)
- Oil Rubbed Bronze (34)
- Stainless/Brushed Nickel (50)

#### PRICE GROUP D

- Polished Gold (8)
- Satin Gold (35)
- Venetian Bronze (47)

# BRAIDED RISERS

4T-295, 4T-296, 4T-297 & 4T-298

ALL BRAIDED RISERS ARE SOLD SEPARATELY

## 4T-295

### FINISHES & PRICE GROUPS:

#### PRICE GROUP A

- Polished Chrome (1)

#### PRICE GROUP B

- Satin Nickel (31)

## 3/8" COMPRESSION X 1/2" IPS X 12" BRAIDED RISER | 4T-295

SINK AND LAVATORY APPLICATIONS

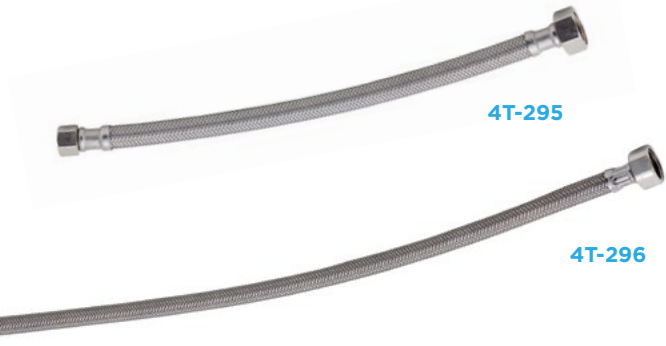

## 4T-296

### FINISHES & PRICE GROUPS:

#### PRICE GROUP A

- Polished Chrome (1)

#### PRICE GROUP C

- Polished Nickel (30)
- Satin Nickel (31)
- Stainless/Brushed Nickel (50)

## 3/8" COMPRESSION X 1/2" IPS X 20" BRAIDED RISER | 4T-296

SINK AND LAVATORY APPLICATIONS



SOLD EACH

## 4T-297

### FINISHES & PRICE GROUPS:

#### PRICE GROUP A

- Polished Chrome (1)

#### PRICE GROUP C

- Polished Nickel (30)
- Satin Nickel (31)
- Stainless/Brushed Nickel (50)

## 3/8" COMPRESSION X 7/8" PLASTIC BALLCOCK CONNECTOR X 12" BRAIDED RISER | 4T-297

## 4T-298

### FINISHES & PRICE GROUPS:

#### PRICE GROUP A

- Polished Chrome (1)

#### PRICE GROUP B

- Satin Nickel (31)
- Stainless/Brushed Nickel (50)

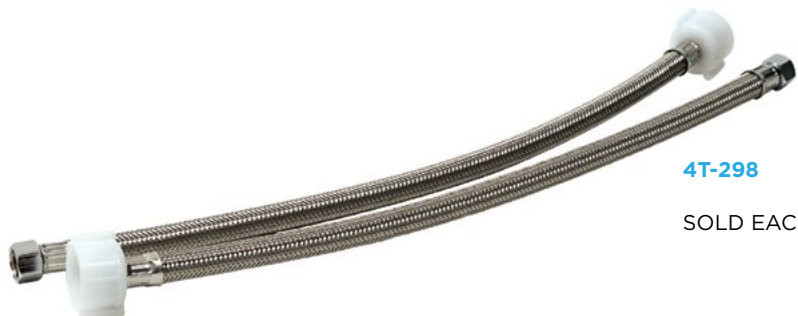

SOLD EACH

## 3/8" COMPRESSION X 7/8" PLASTIC BALLCOCK CONNECTOR X 16" BRAIDED RISER | 4T-298



# 1/2" THREADED BRASS FITTINGS

4T-309, 4T-311, 4T-313, 4T-315, 4T-317, 4T-319, & 4T-323



1/2" IPS 90° ELBOW | 4T-309

4T-309



1/2" IPS COUPLING | 4T-311

4T-311



1/2" IPS 45° ELBOW | 4T-313

4T-313



1/2" IPS TEE | 4T-315

4T-315



1/2" IPS ELBOW 90° STREET | 4T-317

4T-317



1/2" IPS CAP | 4T-319

4T-319



4T-323

1/2" IPS UNION | 4T-323

4T-309, 4T-311, 4T-313, 4T-315,  
4T-317, 4T-319, & 4T-323

## FINISHES & PRICE GROUPS:

### PRICE GROUP A

- Polished Chrome (1)

### PRICE GROUP C

- Polished Brass & PVD (2)
- Antique Brass (3)
- Polished Nickel (30)
- Satin Nickel (31)
- Oil Rubbed Bronze (34)
- Stainless/Brushed Nickel (50)

### PRICE GROUP D

- Uncoated Polished Brass (11)

# 3/8" THREADED BRASS FITTINGS

4T-310, 4T-312, 4T-314, 4T-316, 4T-318, 4T-320 & 4T-3223

3/8" IPS 90° ELBOW | 4T-310



4T-310

3/8" IPS COUPLING | 4T-312



4T-312

3/8" IPS 45° ELBOW | 4T-314



4T-314

3/8" IPS TEE | 4T-316



4T-316

3/8" IPS ELBOW 90° STREET | 4T-318



4T-318

3/8" IPS CAP | 4T-320



4T-320

3/8" IPS UNION | 4T-3223



4T-3223

4T-310, 4T-312, 4T-314, 4T-316,  
4T-318, 4T-320, & 4T-3223  
FINISHES & PRICE GROUPS:

**PRICE GROUP A**

- Polished Chrome (1)

**PRICE GROUP C**

- Polished Brass & PVD (2)
- Satin Nickel (31)

**PRICE GROUP D**

- Uncoated Polished Brass (11)

# 1/2" IPS NIPPLES

1-1/2" TO 11" IN LENGTH

4T-400N TO 4T-414N

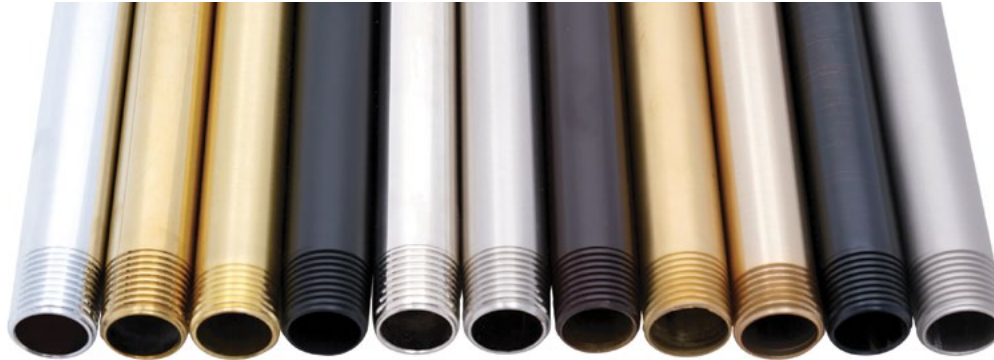

1 2 5 20 30 31 34 35 38 47 50

1/2" IPS X 1-1/2" NIPPLE | [4T-400N](#)

1/2" IPS X 2" NIPPLE | [4T-401N](#)

1/2" IPS X 2-1/2" NIPPLE | [4T-402N](#)

1/2" IPS X 3" NIPPLE | [4T-403N](#)

1/2" IPS X 3-1/2" NIPPLE | [4T-404N](#)

1/2" IPS X 4" NIPPLE | [4T-405N](#)

1/2" IPS X 4-1/2" NIPPLE | [4T-406N](#)

1/2" IPS X 5" NIPPLE | [4T-407N](#)

1/2" IPS X 5-1/2" NIPPLE | [4T-408N](#)

1/2" IPS X 6" NIPPLE | [4T-409N](#)

1/2" IPS X 7" NIPPLE | [4T-410N](#)

1/2" IPS X 8" NIPPLE | [4T-411N](#)

1/2" IPS X 9" NIPPLE | [4T-412N](#)

1/2" IPS X 10" NIPPLE | [4T-413N](#)

1/2" IPS X 11" NIPPLE | [4T-414N](#)

## 4T-400N TO 4T-414N FINISHES & PRICE GROUPS:

### PRICE GROUP A

- Polished Chrome (1)

### PRICE GROUP B

- Flat Black (20)

### PRICE GROUP C

- Polished Brass & PVD (2)
- Satin Brass (5)
- Polished Nickel (30)
- Satin Nickel (31)
- Oil Rubbed Bronze (34)
- Stainless/Brushed Nickel (50)

### PRICE GROUP D

- Uncoated Polished Brass (11)
- Satin Gold (35)  
4T-403N, 4T-405N, 4T-409N,  
4T-411N, 4T-413N only
- Light Brushed Bronze (38)
- Venezian Bronze (47)

# 1/2" IPS NIPPLES

12", 18" & 24" IN LENGTH

4T-415N, 4T-416N, 4T-417N

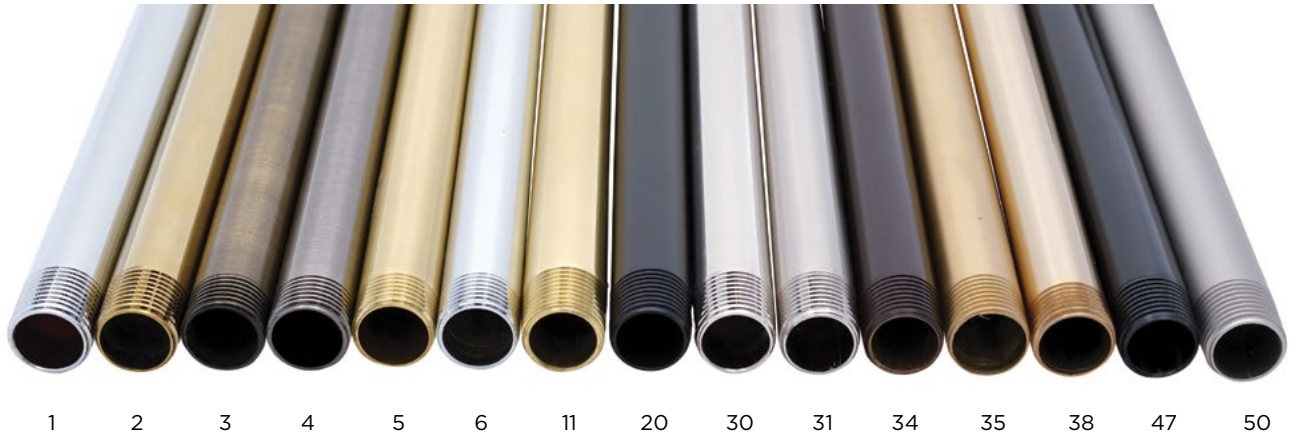

1/2" IPS X 12" NIPPLE | [4T-415N](#)

1/2" IPS X 18" NIPPLE | [4T-416N](#)

1/2" IPS X 24" NIPPLE | [4T-417N](#)

## 4T-415N, 4T-416N, 4T-417N FINISHES & PRICE GROUPS:

### PRICE GROUP A

- Polished Chrome (1)

### PRICE GROUP B

- Flat Black (20)

### PRICE GROUP C

- Polished Brass & PVD (2)
- Antique Brass (3)
- Antique Nickel (Pewter) (4)
- Satin Brass (5)
- Satin Chrome (6)
- Polished Nickel (30)
- Satin Nickel (31)
- Oil Rubbed Bronze (34)
- Stainless/Brushed Nickel (50)

### PRICE GROUP D

- Uncoated Polished Brass (11)
- Satin Gold (35)
- Light Brushed Bronze (38)
- Venetian Bronze (47)

# 1/2" IPS NIPPLES

30", 36", 42", 48", 54" & 60" IN LENGTH

4T-418N, 4T-419N, 4T-421N, 4T-420N, 4T-422N, 4T-423N

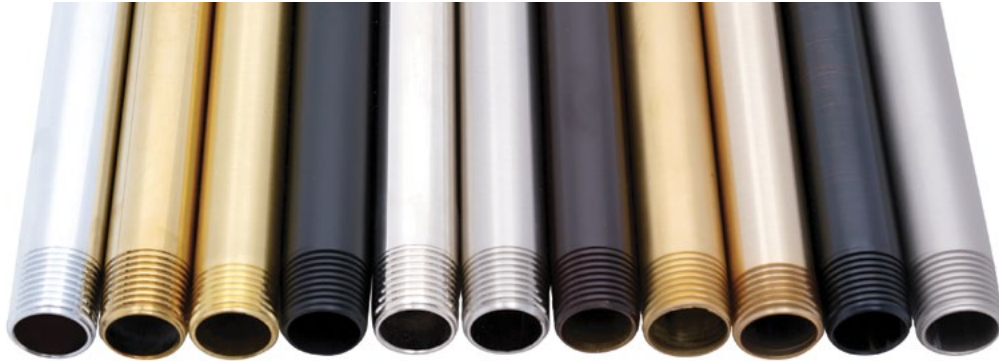

1 2 11 20 30 31 34 35 38 47 50

1/2" IPS X 30" NIPPLE | [4T-418N](#)

1/2" IPS X 36" NIPPLE | [4T-419N](#)

1/2" IPS X 42" NIPPLE | [4T-421N](#)

1/2" IPS X 48" NIPPLE | [4T-420N](#)

1/2" IPS X 54" NIPPLE | [4T-422N](#)

1/2" IPS X 60" NIPPLE | [4T-423N](#)

## 4T-418N, 4T-419N, 4T-421N, 4T-420N, 4T-422N, 4T-423N FINISHES & PRICE GROUPS:

### PRICE GROUP A

- Polished Chrome (1)

### PRICE GROUP B

- Flat Black (20)

### PRICE GROUP C

- Polished Brass & PVD (2)
- Polished Nickel (30)
- Satin Nickel (31)
- Oil Rubbed Bronze (34)
- Stainless/Brushed Nickel (50)

### PRICE GROUP D

- Uncoated Polished Brass (11)
- Satin Gold (35)
- Light Brushed Bronze (38)
- Venetian Bronze (47)



# 3/8" IPS NIPPLES

4T-425N, 4T-426N, 4T-428N, 4T-429N, 4T-430N, 4T-431N,  
4T-432N, 4T-434N, 4T-435N, 4T-436N, 4T-438N, & 4T-440N

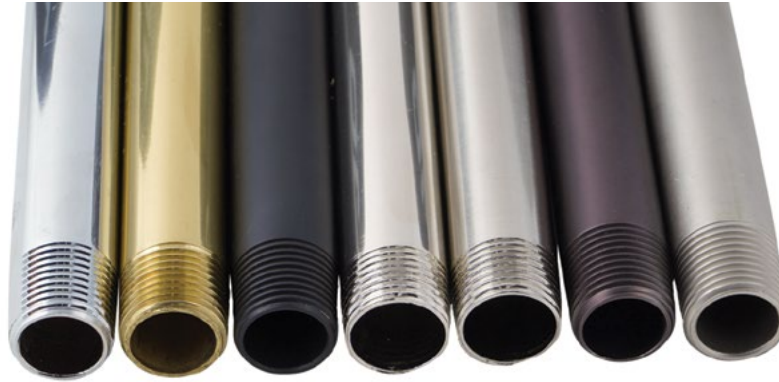

1                      2                      20                      30                      31                      34                      50

4T-425N, 4T-426N, 4T-428N,  
4T-429N, 4T-430N, 4T-432N,  
4T-434N, 4T-435N, 4T-436N,  
4T-438N, & 4T-440N

## FINISHES & PRICE GROUPS:

### PRICE GROUP A

- Polished Chrome (1)

### PRICE GROUP B

- Flat Black (20)

### PRICE GROUP C

- Polished Brass & PVD (2)
- Antique Brass (3)  
4T-430N only
- Antique Nickel (Pewter) (4)  
4T-430N only
- Satin Brass (5)  
4T-430N only
- Polished Nickel (30)
- Satin Nickel (31)
- Oil Rubbed Bronze (34)
- Stainless/Brushed Nickel (50)

### PRICE GROUP D

- Uncoated Polished Brass (11)
- Satin Gold (35)  
4T-430N only
- Light Brushed Bronze (38)  
4T-430N only
- Venezian Bronze (47)  
4T-430N only

3/8" IPS X 1-1/2" NIPPLE | [4T-425N](#)

3/8" IPS X 2" NIPPLE | [4T-426N](#)

3/8" IPS X 3" NIPPLE | [4T-428N](#)

3/8" IPS X 3-1/2" NIPPLE | [4T-429N](#)

3/8" IPS X 4" NIPPLE | [4T-430N](#)

3/8" IPS X 5" NIPPLE | [4T-432N](#)

3/8" IPS X 6" NIPPLE | [4T-434N](#)

3/8" IPS X 7" NIPPLE | [4T-435N](#)

3/8" IPS X 8" NIPPLE | [4T-436N](#)

3/8" IPS X 10" NIPPLE | [4T-438N](#)

3/8" IPS X 12" NIPPLE | [4T-440N](#)

# SURE GRIP FLANGES

4T-261, 4T- 262, 4T- 263, & 4T-266



4T-261

1-1/2" OD SHALLOW PATTERN SURE GRIP FLANGE | 4T-261



4T-262

1-1/2" IPS SHALLOW PATTERN SURE GRIP FLANGE | 4T-262



4T-263

2" OD SHALLOW PATTERN SURE GRIP FLANGE | 4T-263



4T-266

1-1/4" OD SHALLOW PATTERN SURE GRIP FLANGE | 4T-266

4T-261, 4T- 262,  
4T- 263 & 4T-266

## FINISHES & PRICE GROUPS:

### PRICE GROUP A

- Polished Chrome (1)

### PRICE GROUP B

- White (13)
- Gloss Black (15)
- Almond (19)
- Flat Black (20)

### PRICE GROUP C

- Polished Brass & PVD (2)
- Antique Brass (3)
- Satin Brass (5)
- Polished Nickel (30)
- Satin Nickel (31)
- Oil Rubbed Bronze (34)
- Stainless/Brushed Nickel (50)

### PRICE GROUP D

- Satin Gold (35)
- Light Brushed Bronze (38)

# SURE GRIP FLANGES

4T-284, 4T-28438 & 4T-285

1/2" IPS LOW PATTERN SURE GRIP FLANGE | 4T-284



4T-284

3/8" IPS LOW PATTERN SURE GRIP FLANGE | 4T-28438



4T-28438

5/8" OD LOW PATTERN SURE GRIP FLANGE | 4T-285



4T-285

## 4T-284, 4T-28438 & 4T-285 FINISHES & PRICE GROUPS:

### PRICE GROUP A

- Polished Chrome (1)

### PRICE GROUP B

- White (13)
- Gloss Black (15)
- Biscuit (16)
- Almond (19)
- Flat Black (20)

### PRICE GROUP C

- Polished Brass & PVD (2)
- Antique Brass (3)
- Antique Nickel (Pewter) (4)
- Satin Brass (5)
- Satin Chrome (6)
- Polished Nickel (30)

- Satin Nickel (31)
- Oil Rubbed Bronze (34)
- Stainless/Brushed Nickel (50)

### PRICE GROUP D

- Polished Gold (8)
- Uncoated Polished Brass (11)
- Black Nickel (12)
- Light Gold (32)
- Antique Bronze (33)
- Satin Gold (35)
- Antique Copper (36)
- Light Brushed Bronze (38)
- Aged Pewter (40)
- Venezian Bronze (47)

# BELL FLANGES

4T-2588, 4T-303 & 4T-306



4T-2588

1-1/2" OD DEEP PATTERN BELL FLANGE | 4T-2588



4T-303

1/2" OD BELL FLANGE | 4T-303



4T-306

5/8" OD BELL FLANGE | 4T-306

## 4T-2588, 4T-303 & 4T-306 FINISHES & PRICE GROUPS:

### PRICE GROUP A

- Polished Chrome (1)

### PRICE GROUP B

- White (13)
- Almond (19)
- Flat Black (20)

### PRICE GROUP C

- Polished Brass & PVD (2)
- Antique Brass (3)
- Antique Nickel (Pewter) (4)
- Satin Brass (5)

- Satin Chrome (6)
- Polished Nickel (30)
- Satin Nickel (31)
- Oil Rubbed Bronze (34)
- Stainless/Brushed Nickel (50)

### PRICE GROUP D

- Antique Bronze (33)
- Satin Gold (35)
- Light Brushed Bronze (38)
- Aged Pewter (40)
- Venezian Bronze (47)

# BELL FLANGES

4T-307, 4T-308 & 4T-30838

11/16" OD BELL FLANGE | 4T-307



4T-307

1/2" IPS BELL FLANGE | 4T-308



4T-308

3/8" IPS BELL FLANGE | 4T-30838



4T-30838

## 4T-307, 4T-308 & 4T-30838

### FINISHES & PRICE GROUPS:

#### PRICE GROUP A

- Polished Chrome (1)

#### PRICE GROUP B

- White (13)
- Almond (19)
- Flat Black (20)

#### PRICE GROUP C

- Polished Brass & PVD (2)
- Antique Brass (3)
- Antique Nickel (Pewter) (4)
- Satin Brass (5)

- Satin Chrome (6)
- Polished Nickel (30)
- Satin Nickel (31)
- Oil Rubbed Bronze (34)
- Stainless/Brushed Nickel (50)

#### PRICE GROUP D

- Antique Bronze (33)
- Satin Gold (35)
- Light Brushed Bronze (38)
- Aged Pewter (40)
- Venezian Bronze (47)



# HIGH BOX FLANGES

4T-258, 4T-259, 4T-260 & 4T-264



4T-258

1-1/2" OD DEEP PATTERN HIGH BOX FLANGE | 4T-258



4T-259

1-1/4" OD DEEP PATTERN HIGH BOX FLANGE | 4T-259



4T-260

1-1/2" IPS DEEP PATTERN HIGH BOX FLANGE | 4T-260



4T-264

2" OD DEEP PATTERN HIGH BOX FLANGE | 4T-264

## 4T-258, 4T-259, 4T-260 & 4T-264 FINISHES & PRICE GROUPS:

### PRICE GROUP A

- Polished Chrome (1)

### PRICE GROUP B

- White (13)
- Gloss Black (15)
- Almond (19)
- Flat Black (20)

### PRICE GROUP C

- Polished Brass & PVD (2)
- Antique Brass (3)
- Antique Nickel (Pewter) (4)
- Satin Brass (5)

- Satin Chrome (6)

- Polished Nickel (30)

- Satin Nickel (31)

- Oil Rubbed Bronze (34)

- Stainless/Brushed Nickel (50)

### PRICE GROUP D

- Uncoated Polished Brass (11)

- Satin Gold (35)

- Antique Copper (36)

- Light Brushed Bronze (38)

- Aged Pewter (40)

- Venezian Bronze (47)

# LOG LIGHTER TRIM

4T-1916 & 4T-1917

## LOG LIGHTER KIT | 4T-1916

EXPOSED FLANGE AND KEY

FOR PRICE PFISTER, ARROWHEAD BRASS AND SIOUX CHIEF

2" DIAMETER

1-3/4" DEEP



## LOG LIGHTER KEY ONLY | 4T-1917

5/16" X 3"

### 4T-1916 & 4T-1917 FINISHES & PRICE GROUPS:

#### PRICE GROUP A

- Polished Chrome (1)

#### PRICE GROUP B

- White (13)
- Gloss Black (15)
- Flat Black (20)

#### PRICE GROUP C

- Polished Brass & PVD (2)
- Antique Brass (3)
- Satin Brass (5)

- Satin Chrome (6)

- Polished Nickel (30)

- Satin Nickel (31)

- Oil Rubbed Bronze (34)

- Stainless/Brushed Nickel (50)

#### PRICE GROUP D

- Satin Gold (35)

- Antique Copper (36)

- Light Brushed Bronze (38)

- Venezian Bronze (47)

# INDEX OF PRODUCTS

<b>4T-002</b>   30	<b>4T-066A</b>   33	<b>4T-170X</b>   63	<b>4T-208</b>   7
<b>4T-004</b>   30	<b>4T-067</b>   33	<b>4T-171-KIT</b>   63	<b>4T-209</b>   6
<b>4T-005</b>   30	<b>4T-068</b>   32	<b>4T-172</b>   63	<b>4T-209K</b>   6
<b>4T-5NC</b>   30	<b>4T-077G</b>   26	<b>4T-173X</b>   63	<b>4T-210</b>   6
<b>4T-5NCTD</b>   33	<b>4T-090</b>   18	<b>4T-174X</b>   63	<b>4T-211</b>   10
<b>4T-006</b>   30	<b>4T-091</b>   18	<b>4T-176X</b>   66	<b>4T-212</b>   10
<b>4T-007</b>   30	<b>4T-094</b>   29	<b>4T-177X</b>   66	<b>4T-213A</b>   9
<b>4T-020</b>   31	<b>4T-095</b>   29	<b>4T-178X</b>   68	<b>4T-213K</b>   9
<b>4T-021</b>   31	<b>4T-112</b>   81	<b>4T-179X</b>   68	<b>4T-213S</b>   9
<b>4T-029</b>   17	<b>4T-119</b>   81	<b>4T-183A</b>   56	<b>4T-214</b>   10
<b>4T-030</b>   16	<b>4T-121</b>   82	<b>4T-185</b>   54	<b>4T-215</b>   14
<b>4T-031</b>   19	<b>4T-122</b>   82	<b>4T-186</b>   58, 59, 60, 61, 62, 64	<b>4T-215B</b>   14
<b>4T-032</b>   28	<b>4T-128</b>   85	<b>4T-186K</b>   58, 64	<b>4T-215BC-KIT</b>   14
<b>4T-033</b>   29	<b>4T-132</b>   90	<b>4T-186KP</b>   64	<b>4T-215C</b>   14
<b>4T-034</b>   19	<b>4T-141</b>   82	<b>4T-186P</b>   54, 55, 56, 58, 64	<b>4T-215-KIT</b>   14
<b>4T-039</b>   20	<b>4T-145</b>   84	<b>4T-187</b>   55	<b>4T-216</b>   15
<b>4T-040</b>   16, 20	<b>4T-146</b>   86	<b>4T-188</b>   65	<b>4T-216-KIT</b>   15
<b>4T-041</b>   22	<b>4T-147</b>   87	<b>4T-188K</b>   65	<b>4T-217</b>   15
<b>4T-042</b>   17	<b>4T-148</b>   86	<b>4T-189</b>   65	<b>4T-218</b>   15
<b>4T-042GC</b>   28	<b>4T-149</b>   87	<b>4T-190</b>   34	<b>4T-224</b>   35
<b>4T-043</b>   21	<b>4T-150</b>   86	<b>4T-193</b>   34	<b>4T-225</b>   35
<b>4T-044</b>   22	<b>4T-151D</b>   87	<b>4T-194</b>   36	<b>4T-231</b>   11
<b>4T-045</b>   23	<b>4T-152</b>   90	<b>4T-195</b>   36	<b>4T-233</b>   12
<b>4T-046</b>   28	<b>4T-153</b>   91	<b>4T-196</b>   37	<b>4T-234</b>   12
<b>4T-047</b>   23	<b>4T-156</b>   91	<b>4T-197</b>   37	<b>4T-235</b>   12
<b>4T-048</b>   27	<b>4T-160</b>   92	<b>4T-198</b>   37	<b>4T-236</b>   8
<b>4T-049</b>   24	<b>4T-162</b>   94	<b>4T-199X</b>   54	<b>4T-237</b>   8
<b>4T-049J</b>   24	<b>4T-163</b>   94	<b>4T-200</b>   5	<b>4T-238</b>   13
<b>4T-055</b>   32	<b>4T-164</b>   92	<b>4T-202</b>   4	<b>4T-240</b>   13
<b>4T-056</b>   33	<b>4T-165</b>   92	<b>4T-203</b>   4	<b>4T-242</b>   11
<b>4T-062</b>   32	<b>4T-166</b>   93	<b>4T-204</b>   5	<b>4T-245</b>   38
<b>4T-063</b>   25	<b>4T-167</b>   94	<b>4T-205</b>   5	<b>4T-245L</b>   38
<b>4T-064</b>   32	<b>4T-168</b>   93	<b>4T-206</b>   8	<b>4T-246</b>   39
<b>4T-065</b>   32	<b>4T-169</b>   57	<b>4T-207</b>   7	<b>4T-246L</b>   39

## INDEX OF PRODUCTS

<b>4T-247</b>   42	<b>4T-288X</b>   110	<b>4T-371</b>   50	<b>4T-436N</b>   125
<b>4T-249</b>   42	<b>4T-289</b>   112	<b>4T-400N</b>   122	<b>4T-438N</b>   125
<b>4T-250</b>   43	<b>4T-289X</b>   112	<b>4T-401N</b>   122	<b>4T-440N</b>   125
<b>4T-251</b>   40	<b>4T-295</b>   119	<b>4T-402N</b>   122	<b>4T-480</b>   27
<b>4T-251N</b>   40	<b>4T-296</b>   119	<b>4T-403N</b>   122	<b>4T-483</b>   26
<b>4T-253</b>   41	<b>4T-297</b>   119	<b>4T-404N</b>   122	<b>4T-502A</b>   31
<b>4T-253N</b>   41	<b>4T-298</b>   119	<b>4T-405N</b>   122	<b>4T-503P</b>   31
<b>4T-254</b>   44	<b>4T-300</b>   52	<b>4T-406N</b>   122	<b>4T-541</b>   93
<b>4T-254K</b>   44	<b>4T-301</b>   52	<b>4T-407N</b>   122	<b>4T-628</b>   51
<b>4T-255D</b>   46	<b>4T-302</b>   52	<b>4T-408N</b>   122	<b>4T-629</b>   51
<b>4T-258</b>   130	<b>4T-303</b>   128	<b>4T-409N</b>   122	<b>4T-630</b>   52
<b>4T-259</b>   130	<b>4T-304</b>   56	<b>4T-410N</b>   122	<b>4T-631</b>   52
<b>4T-260</b>   130	<b>4T-306</b>   128	<b>4T-411N</b>   122	<b>4T-0663J</b>   25
<b>4T-261</b>   126	<b>4T-307</b>   129	<b>4T-412N</b>   122	<b>4T-682</b>   51
<b>4T- 262</b>   126	<b>4T-308</b>   129	<b>4T-413N</b>   122	<b>4T-701</b>   43
<b>4T- 263</b>   126	<b>4T-309</b>   120	<b>4T-414N</b>   122	<b>4T-715</b>   95
<b>4T-264</b>   130	<b>4T-310</b>   121	<b>4T-415N</b>   88, 123	<b>4T-715X</b>   95
<b>4T-265</b>   53	<b>4T-311</b>   120	<b>4T-416N</b>   88, 123	<b>4T-716</b>   96
<b>4T-265A</b>   53	<b>4T-312</b>   121	<b>4T-417N</b>   88, 123	<b>4T-716X</b>   96
<b>4T-265G</b>   53	<b>4T-313</b>   120	<b>4T-418N</b>   89, 124	<b>4T-717</b>   97
<b>4T-266</b>   126	<b>4T-314</b>   121	<b>4T- 419N</b>   89, 124	<b>4T-717X</b>   97
<b>4T-267</b>   49	<b>4T-315</b>   120	<b>4T-420N</b>   89, 124	<b>4T-718</b>   98
<b>4T-267A</b>   49	<b>4T-316</b>   121	<b>4T- 421N</b>   89, 124	<b>4T-718X</b>   98
<b>4T-268</b>   49	<b>4T-317</b>   120	<b>4T-422N</b>   89, 124	<b>4T-725</b>   99
<b>4T-268A</b>   49	<b>4T-318</b>   121	<b>4T-423N</b>   89, 124	<b>4T-725X</b>   99
<b>4T-283</b>   53	<b>4T-319</b>   120	<b>4T-425N</b>   125	<b>4T-726</b>   99
<b>4T-283C</b>   53	<b>4T-320</b>   121	<b>4T-426N</b>   125	<b>4T-726X</b>   99
<b>4T-284</b>   127	<b>4T-323</b>   120	<b>4T-428N</b>   125	<b>4T-727</b>   100
<b>4T-285</b>   127	<b>4T-335</b>   54	<b>4T-429N</b>   125	<b>4T-727X</b>   100
<b>4T-286</b>   105	<b>4T-336</b>   54	<b>4T-430N</b>   125	<b>4T-728</b>   101
<b>4T-286X</b>   105	<b>4T-367</b>   50	<b>4T-431N</b>   125	<b>4T-728X</b>   101
<b>4T-287</b>   107	<b>4T-368</b>   50	<b>4T-432N</b>   125	<b>4T-1020</b>   78
<b>4T-287X</b>   107	<b>4T-369</b>   50	<b>4T-434N</b>   125	<b>4T-1060</b>   79
<b>4T-288</b>   110	<b>4T-370</b>   50	<b>4T-435N</b>   125	<b>4T-1072</b>   79

# INDEX OF PRODUCTS

<b>4T-1090</b>   79	<b>4T-1904C</b>   60	<b>4T-3815X</b>   118	<b>4T-39312</b>   107
<b>4T-1150</b>   80	<b>4T-1904CB</b>   60	<b>4T-3820</b>   118	<b>4T-39312X</b>   107
<b>4T-1160</b>   81	<b>4T-1905C</b>   61	<b>4T-3820X</b>   118	<b>4T-39412</b>   112
<b>4T-1170</b>   81	<b>4T-1905CB</b>   61	<b>4T-4240</b>   17	<b>4T-39412X</b>   112
<b>4T-1190</b>   80	<b>4T-1906C</b>   62	<b>4T-5599</b>   74	<b>4T-39612</b>   106
<b>4T-1760X</b>   67	<b>4T-1906CB</b>   62	<b>4T-5599E</b>   75	<b>4T-39612X</b>   106
<b>4T-1773A</b>   76	<b>4T-1907C</b>   62	<b>4T-6420</b>   33	<b>4T-39812</b>   111
<b>4T-1774A</b>   76	<b>4T-1907CB</b>   62	<b>4T-7711D</b>   69	<b>4T-39812X</b>   111
<b>4T-1775A</b>   76	<b>4T-1916</b>   131	<b>4T-7722D</b>   69	<b>4T-55138</b>   109
<b>4T-1776A</b>   76	<b>4T-1917</b>   131	<b>4T-9855D</b>   70	
<b>4T-1777A</b>   76	<b>4T-2551D</b>   45	<b>4T-9922D</b>   67	
<b>4T-1779A</b>   77	<b>4T-2565</b>   46	<b>4T-28328</b>   104	
<b>4T-1780A</b>   77	<b>4T-2566</b>   45	<b>4T-28438</b>   127	
<b>4T-1781A</b>   77	<b>4T-2566K</b>   45	<b>4T-28638</b>   105	
<b>4T-1782A</b>   77	<b>4T-2577</b>   47	<b>4T-28638X</b>   99, 105	
<b>4T-1783A</b>   77	<b>4T-2588</b>   128	<b>4T-28738</b>   108	
<b>4T-1800A</b>   70	<b>4T-2738</b>   102	<b>4T-28738X</b>   108	
<b>4T-1802A</b>   71	<b>4T-2739</b>   102	<b>4T-28838</b>   110	
<b>4T-1803A</b>   71	<b>4T-2780</b>   102	<b>4T-28838X</b>   110	
<b>4T-1804A</b>   72	<b>4T-2781D</b>   102	<b>4T-28938</b>   113	
<b>4T-1805A</b>   72	<b>4T-2799</b>   103	<b>4T-28938X</b>   113	
<b>4T-1833</b>   56	<b>4T-2800</b>   103	<b>4T-29212</b>   116	
<b>4T-1850A</b>   55	<b>4T-2838</b>   104	<b>4T-29212X</b>   116	
<b>4T-1850B</b>   55	<b>4T-2839</b>   103	<b>4T-29238</b>   117	
<b>4T-1869</b>   55	<b>4T-2840</b>   104	<b>4T-29238X</b>   117	
<b>4T-1870</b>   55	<b>4T-2940</b>   17	<b>4T-29412</b>   116	
<b>4T-1900C</b>   58	<b>4T-3040</b>   16	<b>4T-29412X</b>   116	
<b>4T-1900CB</b>   58	<b>4T-3223</b>   121	<b>4T-29438</b>   117	
<b>4T-1901C</b>   58	<b>4T-3648</b>   48	<b>4T-29438X</b>   117	
<b>4T-1901CB</b>   58	<b>4T-3649</b>   48	<b>4T-30838</b>   129	
<b>4T-1902C</b>   59	<b>4T-3650</b>   48	<b>4T-38638</b>   114	
<b>4T-1902CB</b>   59	<b>4T-3812</b>   118	<b>4T-38638X</b>   114	
<b>4T-1903C</b>   60	<b>4T-3812X</b>   118	<b>4T-38838</b>   115	
<b>4T-1903CB</b>   60	<b>4T-3815</b>   118	<b>4T-38838X</b>   115	



# TERMS AND CONDITIONS OF SALE

**LIMITED WARRANTY:** Trim To The Trade warrants that its products are free from defects in materials and workmanship for a period of 90 days to the user thereof. Warranty (1) does not include, and Trim To The Trade does not assume any liability for, (a) the finish or wearing quality thereof on any of its products, (b) any obligation other than replacement of the defective product upon presentation thereof to Trim to The Trade during the warranty period, (c) any labor charges, removal and installation expenses, freight or postage to or from Trim To The Trade or any incidental or consequential damages resulting from any defective product and (2) is in lieu of all other warranties, expressed or implied.

Some states do not allow limitations on how long an implied warranty lasts, so the above limitation may not apply. Some states do not allow the exclusion or limitation of incidental or consequential damages, so the above limitation or exclusion may not apply.

This warranty gives you specific legal rights, and you may have other rights which vary from state to state.

**PRODUCT LIABILITY:** Insurance statements are available upon request.

**PRICES:** Prices are listed in our separate "Price List". If you are missing a price list, please visit our website [trimtothetrade.com](http://trimtothetrade.com) to download the most current price list or contact Customer Service.

Prices listed are Suggested Retail Prices. Prices are subject to change without notice. Prices are listed in US Currency.

**MINIMUM INVOICE CHARGE:** There is no minimum billing to ship to you our customer. However, there is a \$30.00 net minimum to ship directly to your customer. Air orders exempt.

**FREIGHT:** Shipper reserves the right to ship merchandise by method of our choosing. Shipments are F.O.B. Palm Desert, California. Full Freight Allowed on shipments of \$600.00 NET invoice value within the continental United States. Full Freight allowed on shipments of \$1700.00 NET invoice value to Hawaii, Alaska, and Canada. Freight allowance will not apply to customers outside the United States and Canada boundaries. We will not ship merchandise collect to your customer. Trim To The Trade places insurance on all shipments leaving our warehouse, covering damage or loss, for full value of shipment. Insurance charges are automatically added to freight charges on invoices to you.

Freight Collect shipments require your UPS/FED EX account number.

When customer requests special handling, any next day, second day, third day, etc., it is the customer's responsibility to notify Trim to the Trade of any handling discrepancies within one week, as the carriers have a time limit for this type of dispute.

We are only responsible for the number of cartons the customer signs for.

**RETURNS:** Merchandise cannot be returned without prior authorization from our returns department. All returns are subject to a minimum of 30% restocking charge. All returns must be properly packaged and accompanied by either a copy of the original invoice or packing slip. Shipping charges for returned merchandise must be prepaid. No C.O.D.'s will be accepted. Credits are issued upon inspection. We do not even-exchange, or swap merchandise. We will re-invoice replacement merchandise and credit the returned merchandise. If we receive merchandise that is not from Trim to the Trade you will be notified immediately and will have 30 days to respond. After 30 days the merchandise will be scrapped.

**RETURN AUTHORIZATIONS:** Any materials returned, other than defective items, will carry the following re-stock charges:

30% - Items returned within 30 days from Invoice date

30% - Items returned between 1-3 months

40% - Items returned between 4-6 months

50% - Items returned between 6-12 months

**NO RETURNS** on items over one year old, regardless if defective or not.

**CLAIMS:** All claims for defective merchandise, shipment shortages, and billing errors, must be made within one week after receipt of goods.

**PRODUCT MODIFICATION:** We reserve the right to modify any product contained herein without any prior notice.

**TRIM TO THE TRADE:** Shall not be responsible for typographical errors and will not be held responsible for any liability associated with misprints, errors and/or pricing discrepancies in this publication.

**POSSESSION OF THIS CATALOG DOES NOT CONSTITUTE ANY OFFER TO SELL.**



**Trim to the Trade**

**Orders and Inquiries:  
[customerservice@trimtothetrade.com](mailto:customerservice@trimtothetrade.com)**

**[trimtothetrade.com](http://trimtothetrade.com)**

**Office 760-343-3306  
Fax 800-562-9998**

**77551 El Duna Court, Suite J  
Palm Desert, CA 92211**